

**Future**

**reflex**

2 INDICE *INDEX*

8 BUFFET e BUFFET LOW *BUFFETS and BUFFETS LOW*

88 MADIE *CUPBOARDS*

116 LIBRERIA, BAR e PORTA TV *BOOKSHELVES, BARS and TV- STANDS*

194 SPECCHI *MIRRORS*

248 CONSOLLE *CONSOLES*

280 UFFICIO *OFFICE*

Buffets



Avantgarde buffet  
Pag. 76



Avantgarde credenza luce  
Pag. 80



Big Ben buffet  
Pag. 16



Coco de mer buffet  
Pag. 20



Impact buffet  
Pag. 24



Kubo buffet  
Pag. 72



London buffet  
Pag. 50



Mirage buffet  
Pag. 30



Monolite buffet  
Pag. 38



Monolite buffet art  
Pag. 42



Musa buffet  
Pag. 46



Musa buffet alto  
Pag. 48



Oh buffet  
Pag. 10



Onis buffet  
Pag. 74



Origami maxi buffet  
Pag. 62



Prisma buffet  
Pag. 68



Quartz buffet  
Pag. 56



San Marco buffet  
Pag. 82



Segno buffet  
Pag. 28



Vertigo buffet  
Pag. 70

Buffets low



Avantgarde credenza low  
Pag. 78



Impact buffet low  
Pag. 26



Mirage buffet low  
Pag. 34



Monolite buffet low  
Pag. 44



Oh buffet low  
Pag. 14



San Marco buffet low  
Pag. 86

Madie / Cupboards



Big ben bar  
Pag. 90



Glass showcase  
Pag. 114



London madia  
Pag. 96



Musa madia  
Pag. 100



Oh madia  
Pag. 106



Onis rectangular  
Pag. 112



Quartz madia  
Pag. 104



San Marco madia  
Pag. 110

Librerie / Bookcases



Aurora  
Pag. 146



Avantgarde libreria  
Pag. 188



Origami collection  
Pag. 118



Prisma libreria  
Pag. 140



Segno libreria  
Pag. 172



System 01  
Pag. 152



Tango libreria  
Pag. 138



Tango T libreria  
Pag. 128

Bar e Porta TV / Bar and TV-stand



Avantgarde bar Special  
Pag. 192



Avantgarde TV  
Pag. 184



Coco de Mer bar  
Pag. 144



Luna Hi-fi  
Pag. 180



Mirage porta TV  
Pag. 182



Movie porta TV special  
Pag. 176

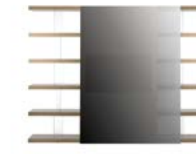

Tango libreria anta TV  
Pag. 136



Tango T libreria anta TV  
Pag. 132

Specchi / Mirrors



Elisa Specchio  
Pag. 238



Impact specchio  
Pag. 196



Impact supersilver  
Pag. 244



Luce specchio  
Pag. 240



Mondrian specchio  
Pag. 210



Nautilus specchio  
Pag. 206



Oh frame specchio  
Pag. 224



Prisma specchio  
Pag. 218



Quartz specchio  
Pag. 220



Seventy specchio  
Pag. 226



Seventy Vetro Marmo  
Pag. 230



Shelf specchio  
Pag. 234



Titanium specchio  
Pag. 200

Specchi TV / Mirrors TV



Movie porta TV  
Pag. 246



Oh frame specchio TV  
Pag. 222



Prisma specchio TV  
Pag. 214





Avantgarde console  
Pag. 276



Avantgarde console long  
Pag. 278



Bamboo console  
Pag. 274



Cubitum console  
Pag. 264



Esse console  
Pag. 252



Fili d'erba console  
Pag. 270



Foulard console  
Pag. 250



Gran canal console  
Pag. 272



Monolite console  
Pag. 262



Neolitico console vetro  
Pag. 258



Oh console  
Pag. 256



Parentesis console  
Pag. 260



Prisma steel console  
Pag. 266



Prisma steel console  
autoportante  
Pag. 268



Signore degli Anelli  
console  
Pag. 254



Luce scrivania  
Pag. 290



Mach 5  
Pag. 294



Pegaso  
Pag. 288



Petalò  
Pag. 298



Prisma steel scrivania  
Pag. 292



Segno scrivania  
Pag. 286



Twist  
Pag. 296



Vele scrivania  
Pag. 282



Amet chair office  
Pag. 306



Comfort chair office  
Pag. 304



Ludwig chair office  
Pag. 302



Vela chair office  
Pag. 300



Zenith chair office  
Pag. 308

*Buffet e buffet low*  
**buffet and buffet low**

Buffets



Avantgarde buffet  
Pag. 76



Avantgarde credenza luce  
Pag. 80



Big Ben buffet  
Pag. 16



Coco de mer buffet  
Pag. 20



Impact buffet  
Pag. 24



Kubo buffet  
Pag. 72



London buffet  
Pag. 50



Mirage buffet  
Pag. 30



Monolite buffet  
Pag. 38



Monolite buffet art  
Pag. 42



Musa buffet  
Pag. 46



Musa buffet alto  
Pag. 48



Oh buffet  
Pag. 10



Onis buffet  
Pag. 74



Origami maxi buffet  
Pag. 62



Prisma buffet  
Pag. 68



Quartz buffet  
Pag. 56



San Marco buffet  
Pag. 82



Segno buffet  
Pag. 28



Vertigo buffet  
Pag. 70

Buffets low



Avantgarde credenza low  
Pag. 78



Impact buffet low  
Pag. 26



Mirage buffet low  
Pag. 34



Monolite buffet low  
Pag. 44



Oh buffet low  
Pag. 14



San Marco buffet low  
Pag. 86



# OH BUFFET

Design · Tulczinsky



Structure in satin Brass 104M finish ◀  
Doors covered in leather Cat. C  
Fumo with Emerald quilting

Structure in Bronze 100M finish ▶  
Doors covered in leather Nabuk  
Tortora with Emerald quilting  
215 x 55 x 78 h





# OH BUFFET

Design · Tulczinsky

► Structure in Bronze 100M finish  
Doors covered in leather Nabuk  
Grigio chiaro with San Marco quilting  
Custom 268 x 55 x 78 h





# OH BUFFET LOW

Design · Tulczinsky



Structure in Bronze 100M finish ◀  
Doors covered in leather Cat. C  
Platino with Hexagon quilting

Structure in Sunbronze 110M finish ▶  
Doors covered in leather Nabuk  
Sabbia with Exagon quilting  
215 x 40 x 53 h







# BIG BEN BUFFET

Design · Riccardo Lucatello



Detail of metal gears in mixed ►  
Gold and shiny Chrome finishing

External cover in Nero ◀  
Beluga lacquered glass  
Metal legs in satin Brass 104M finish  
1 door in Mesh glass with  
metal gears in mixed Gold  
and shiny Chrome finishing  
220 x 50 x 84 h







# BIG BEN BUFFET

Design · Riccardo Lucatello



► External cover in Nero Beluga lacquered glass  
1 door in Mesh glass with metal gears  
in mixed Gold and shiny Chrome finishing  
Custom 220 x 50 x 84 h







# COCO DE MER BUFFET

Design · Riccardo Lucatello

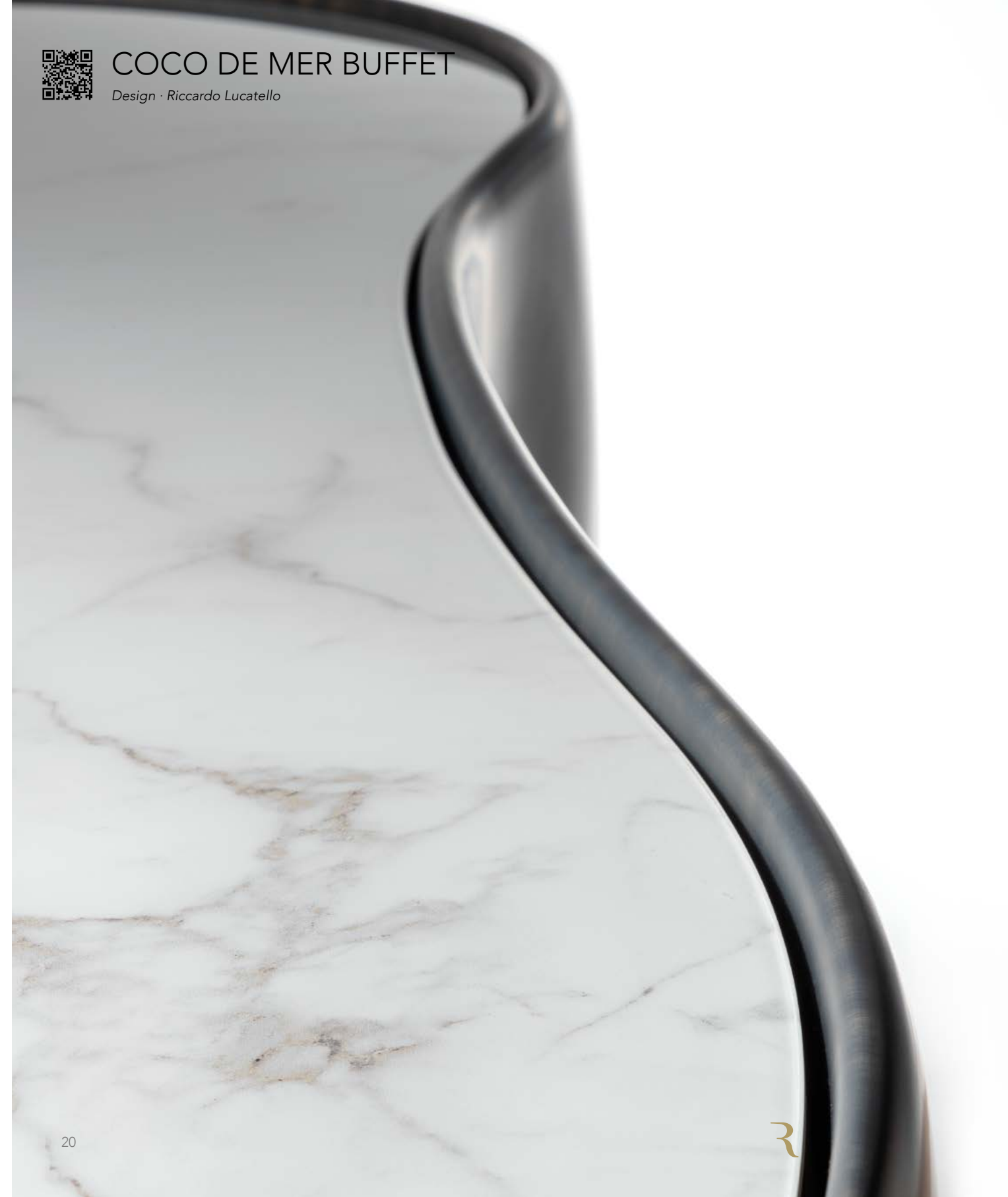

Shaped detail with MarmoReflex ◀  
top in Calacatta Oro

Shaped sideboard lacquered in ▶  
satin Dark Brass 105M finish  
Top in MarmoReflex Calacatta Oro  
181 x 58 x 86 / 145 h







# COCO DE MER BUFFET

Design · Riccardo Lucatello



◀ Internal storage unit detail  
equipped with glass shelves

▶ Shaped sideboard lacquered in  
satin Dark Brass 105M finish  
Top in MarmoReflex Calacatta Oro  
181 x 58 x 86 / 145 h





# IMPACT BUFFET

Design · R&C Reflex



Decoration detail in Gold finish ◀  
Wooden structure in shiny  
lacquered finish Latte colour

Wooden structure in shiny ▶  
lacquered finish Latte colour  
Decoration in Gold finish  
210 x 53 x 74 h





# IMPACT BUFFET LOW

Design · R&C Reflex



R

Decoration detail in satin Brass 104M finish ◀

Wooden structure in shiny ▶  
lacquered finish Latte colour  
Decoration in satin Brass 104M finish  
260 x 50 x 53 h



R



# SEGNO BUFFET

Design · *pininfarina*



Detail of the open section ◀  
in satin Dark Brass 105M finish  
Wooden structure in shiny  
lacquered Blu notte colour  
Metal legs in satin Dark Brass 105M finish

Wooden structure in shiny ▶  
lacquered Fumo colour  
Metal legs in satin Dark Brass 105M finish  
Open section in satin Dark Brass 105M finish  
250 x 55 x 75 h





# MIRAGE BUFFET

Design · R&C Reflex



Structure covered in MarmoReflex: ◀  
240 x 57 x 70 h Sahara  
288 x 57 x 70 h Calacatta Oro

Structure covered in ▶  
LegnoReflex Ebano chiaro  
Legs in Transparent glass  
240 x 57 x 70 h



# MIRAGE BUFFET

Design · R&C Reflex



- Structure covered in shiny lacquered glass Blu notte colour
- Legs in Bronze 100M finish
- Custom 400 x 57 x 70 h





# MIRAGE BUFFET LOW

Design · R&C Reflex



Structure in shiny lacquered glass: ◀  
240 x 57 x 55 h Rosso rubino  
288 x 57 x 55 h Latte

Structure covered in shiny ▶  
lacquered glass Blu notte colour  
288 x 57 x 55 h



# MIRAGE BUFFET LOW

Design · R&C Reflex



► Structure covered in  
MarmoReflex Amani Grigio  
Custom 400 x 57 x 55 h





# MONOLITE BUFFET

Design · Riccardo Lucatello



Wooden structure covered ◀  
in etched lacquered  
glass Hennè colour  
Profile and plinth in Bronze 100M finish

Wooden structure covered in ▶  
MarmoReflex Sahara  
Profile and plinth in Bronze 100M finish  
220 x 45 x 75 h



# MONOLITE BUFFET

Design · Riccardo Lucatello



► Wooden structure covered in  
LegnoReflex Ebano scuro  
Profile and plinth in Bronze 100M finish  
Custom 440 x 45 x 75 h





# MONOLITE BUFFET ART

Design · Riccardo Lucatello



Detail in MarmoReflex ART 01 ◀

Wooden structure covered in ▶  
MarmoReflex ART 02  
Profile and plinth in Bronze 100M finish  
220 x 45 x 75 h





# MONOLITE BUFFET LOW

Design · Riccardo Lucatello



Detail in MarmoReflex ◀  
Onice Grigio

Wooden structure covered in ▶  
MarmoReflex Calacatta Oro  
Profile and plinth in Bronze 100M finish  
220 x 45 x 55 h





# MUSA BUFFET

Design · GianMarco Codato & Luciano Trevisiol



Wooden structure covered ◀  
in MarmoReflex Sahara  
Handle details and metal  
base in Bronze 100M finish

Wooden structure covered ▶  
in MarmoReflex Onice bianco  
Handle details and metal  
base in Sunbronze 110M finish  
220 x 45 x 80 h



# MUSA BUFFET ALTO

Design · GianMarco Codato & Luciano Trevisiol



R

Details of doors opening ◀

Wooden structure covered in ▶  
MarmoReflex Grey St. Laurent  
Handle details and metal  
base in Bronze 100M finish  
220 x 45 x 80 h



R



# LONDON BUFFET

Design · Emanuele Missaglia

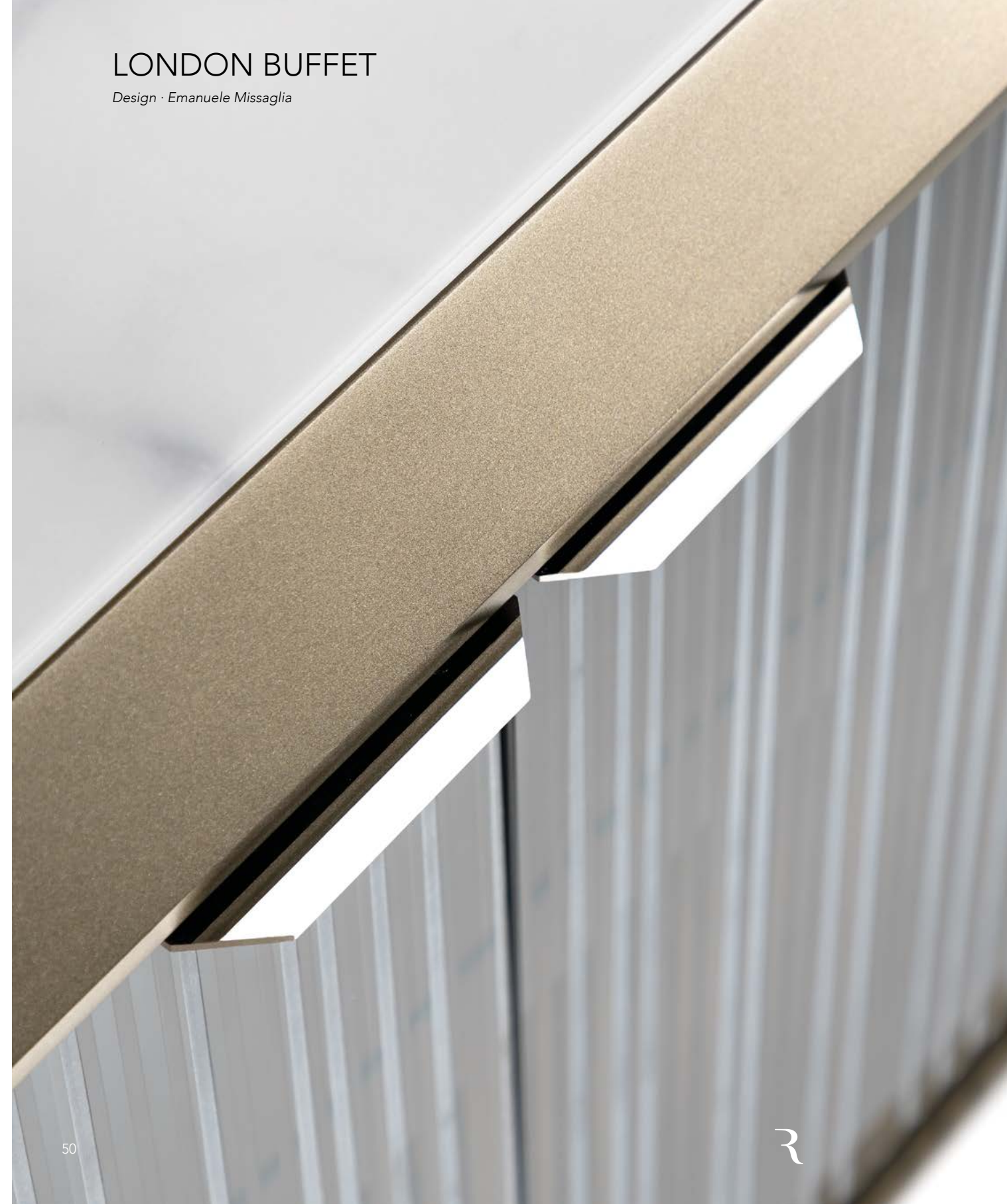

Handles detail ◀

Supersilver glass structure with two central doors and ▶  
central section of the back with London engravings  
Wooden bottom, top and metal base in Bronze 100M finish  
MarmoReflex top cover in Calacatta  
201 x 46,5 x 74,5 h





# LONDON BUFFET

Design · Emanuele Missaglia



Supersilver glass structure with the two central doors and central section of the back with London engravings  
Wooden bottom, top and metal base in Bronze 100M finish  
MarmoReflex top cover in Calacatta  
201 x 46,5 x 74,5 h

Structure and doors in Extra clear transparent glass  
with back in MarmoReflex Amani grigio  
Wooden bottom, top and metal base in Bronze 100M finish  
MarmoReflex top cover in Amani grigio  
201 x 46,5 x 74,5 h





# LONDON BUFFET

Design · Emanuele Missaglia



► Structure and doors in Extra clear transparent glass  
Wooden bottom, top and metal base in Bronze 100M finish  
MarmoReflex top cover in Sahara  
201 x 46,5 x 74,5 h





# QUARTZ BUFFET

Design · Riccardo Lucatello



Wooden structure in Canaletto Hennè ◀  
Legs in satin Brass 104M finish  
210 x 56 x 85 h



# QUARTZ BUFFET

Design · Riccardo Lucatello



Details of doors opening and ◀  
internal glass shelves

Wooden structure in Canaletto walnut ▶  
Legs in Transparent glass  
210 x 56 x 85 h



# QUARTZ BUFFET

Design · Riccardo Lucatello



► Wooden structure in satin Brass 104M finish  
Legs in Transparent glass  
Custom 350 x 56 x 85 h





# ORIGAMI MAXI BUFFET

Design · R&C Reflex



Wooden structure in Bronze 100M finish ◀  
Legs in metal Bronze 100M finish  
210 x 56 x 82 h



# ORIGAMI MAXI BUFFET

Design · R&C Reflex



R

Wooden structure in Bronze 100M finish ◀  
Legs in metal Bronze 100M finish

Wooden structure and legs ▶  
in Sunbronze 110M finish  
210 x 56 x 82 h



R

# ORIGAMI MAXI BUFFET

Design · R&C Reflex



► Wooden structure in Bronze 100M finish  
Legs in Transparent glass  
Custom 420 x 56 x 82 h





# PRISMA BUFFET

Design · Riccardo Lucatello



Details in matt lacquered ◀  
Bordeaux colour  
Legs in metal Brass 104M finish

Wood structure lacquered ▶  
in shiny Fumo colour  
Legs in Transparent glass  
220 x 57 x 73 h





# VERTIGO BUFFET

Design · Riccardo Lucatello

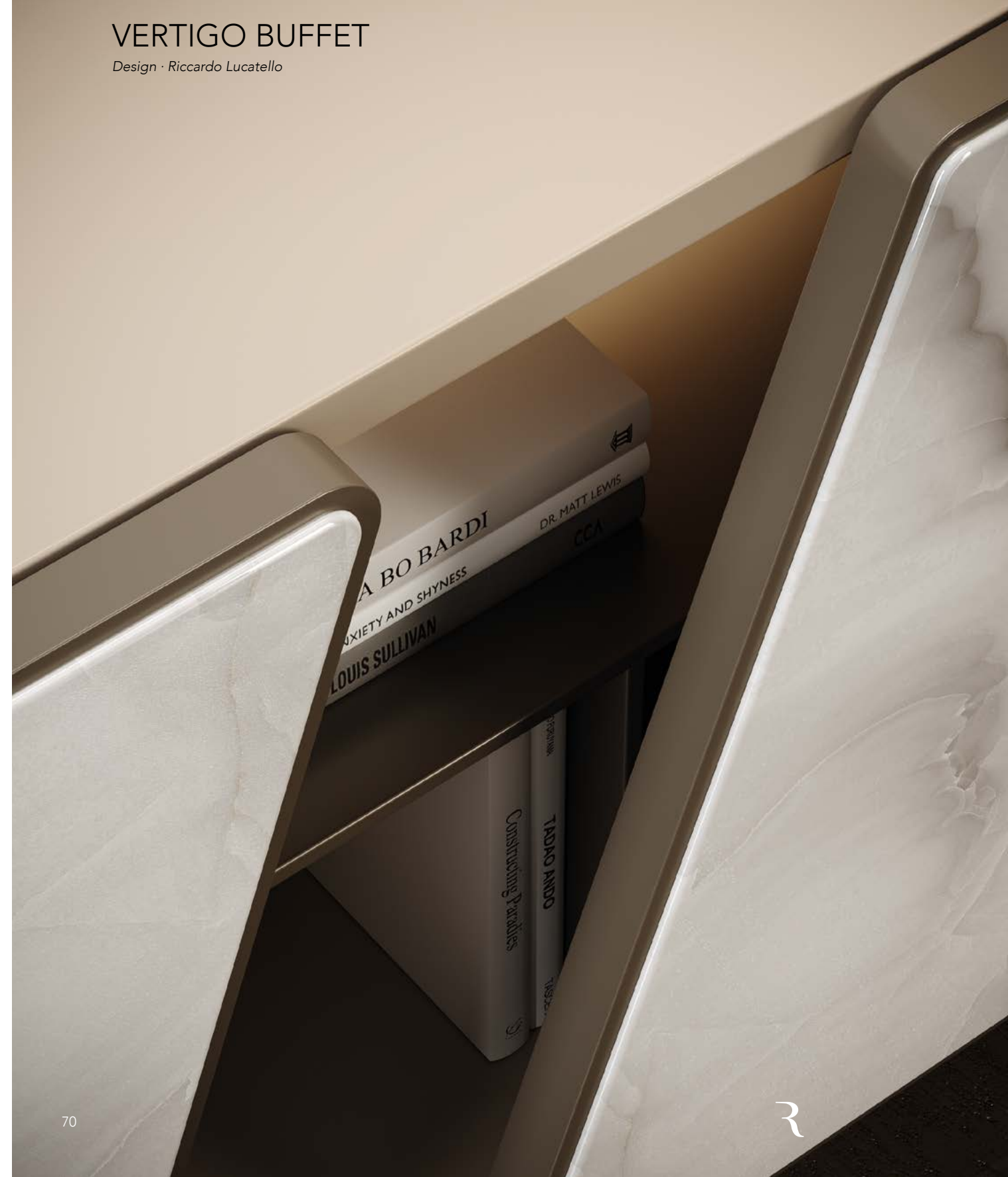

Sliding doors detail ◀

Wooden structure lacquered ▶  
in shiny Fumo colour  
2 sliding doors in Bronze 100M finish with  
MarmoReflex Calacatta Oro  
Back in Smoked mirror glass  
Shelves in the open space  
in wood satin Brass 104M finish  
Metal legs in satin Brass 104M finish  
210 x 53 x 80 h





# KUBO BUFFET

Design · Riccardo Lucatello



Doors opening detail ◀

Structure in shiny lacquered ▶  
wood Verde militare colour  
Support in Extra clear glass  
210 x 60 x 90 h





# ONIS BUFFET

Design · Tulczinsky



Tree decoration detail ◀

Structure in Extra clear frosted glass ▶  
Top in Bush-hammered glass finish  
Metal base in Aluminium colour

Version with Tree decoration  
210 x 55 x 75 h





# AVANTGARDE BUFFET

Design · R&C Reflex



Details in shiny ◀  
lacquered Verde militare colour

Structure in shiny lacquered ▶  
wood Fumo colour  
Top and details on fronts in  
bevelled lacquered glass Fumo colour  
210 x 55 x 94 h





# AVANTGARDE CREDENZA LOW

Design · R&C Reflex



Detail in Smoked Mirror glass ◀

Structure in shiny lacquered wood Latte colour ▶  
Top and fronts with application of bevelled  
lacquered glass matching the structure  
266 x 46 x 56 h





# AVANTGARDE CREDENZA LUCE

Design · R&C Reflex



R

Doors opening detail ◀

Structure in shiny lacquered ▶  
wood Hennè colour  
Top and details on fronts in bevelled  
lacquered glass Hennè colour  
Doors covered in LegnoReflex Ebano chiaro  
216 x 45 x 97 h



R



# SAN MARCO BUFFET

Design · Tulczinsky



Wooden structure in Canaletto Walnut ◀  
Sides covered with leather Cat. C  
Ghiaccio with San Marco quilting  
Top in MarmoReflex Onice Bianco with  
profile in satin Brass 104M finish

Wooden structure in Canaletto Walnut ▶  
Doors with Brass 104M handle with wood detail  
Sides covered with leather Nabuk  
Grigio chiaro with Emerald quilting  
Top in MarmoReflex Onice Grigio with  
profile in satin Brass 104M finish  
226 x 50 x 80 h





# SAN MARCO BUFFET

Design · Tulczinsky



- Wooden structure in Canaletto Walnut
- Doors with Brass 104M handle with wood detail
- Sides covered with leather Cat. C Ghiaccio with San Marco quilting
- Top in MarmoReflex Onice Bianco with profile in satin Brass 104M finish
- Custom 385 x 50 x 80 h





# SAN MARCO BUFFET LOW

Design · Tulczinsky



Wooden structure in Canaletto Hennè ◀  
Sides covered with leather Nabuk Sabbia with San Marco quilting  
Top in MarmoReflex Onice Bianco with profile in satin Brass 104M finish  
230 x 43 x 57 h

Wooden structure in Canaletto Hennè ▶  
Sides covered with leather Nabuk Sabbia with Millerighe quilting  
Top in MarmoReflex Onice Bianco with profile in satin Brass 104M finish  
276 x 43 x 57 h







Big ben bar  
Pag. 90



Glass showcase  
Pag. 114



London madia  
Pag. 96



Musa madia  
Pag. 100



Oh madia  
Pag. 106



Onis rectangular  
Pag. 112



Quartz madia  
Pag. 104



San Marco madia  
Pag. 110

Madie  
cupboards





# BIG BEN BAR

Design · Riccardo Lucatello

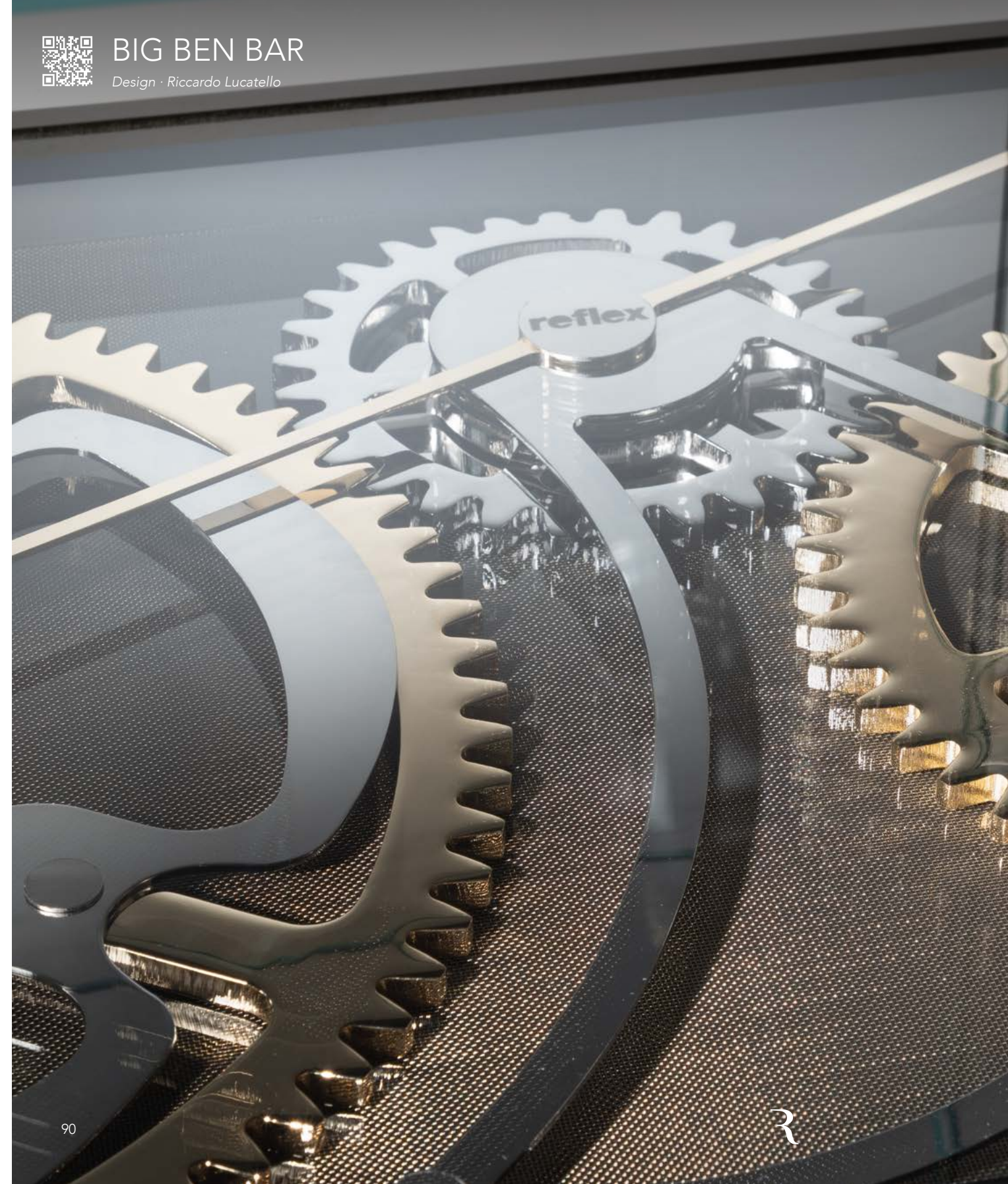

Gears detail in shiny Gold and Chrome ◀  
finish on a Mesh glass background

Structure and shelves in Extra clear glass ▶  
Wooden bottom and top and metal  
base in Bronze 100M finish  
MarmoReflex top cover in Calacatta  
Gears in shiny Gold and Chrome  
finish on a Mesh glass background  
134 x 51 x 160 h







# BIG BEN BAR

Design · Riccardo Lucatello



Structure and shelves in Extra clear glass ◀  
 Wooden bottom and top and metal  
 base in Bronze 100M finish  
 MarmoReflex top cover in Calacatta  
 Gears in shiny Gold and Chrome  
 finish on a Mesh glass background  
 134 x 51 x 160 h







BIG BEN BAR

Design · Riccardo Lucatello



R

*Edizione numerata  
Prototipo 000*

Structure and shelves in Extra-clear glass ▶  
Wooden bottom and top and metal  
base in Bronze 100M finish  
MarmoReflex top cover in Calacatta  
Gears in shiny Gold and Chrome  
finish on a Mesh glass background  
134 x 51 x 160 h



R



# LONDON MADIA

Design · Emanuele Missaglia



Top in Bronze 100M finish with cover ◀  
in Amani Grigio MarmoReflex  
Handles in shiny Chrome

Wooden bottom and top and ▶  
metal base in Bronze 100M finish  
MarmoReflex top cover in Amani Grigio  
Supersilver glass structure with the 2 doors  
and central section of the back with London engravings  
100 x 50 x 150 h

R



R



# LONDON MADIA

Design · Emanuele Missaglia



Wooden top in Bronze 100M finish with  
cover in Marmoreflex Amani Grigio ◀

Wooden bottom and top and metal ▶  
base in Bronze 100M finish  
MarmoReflex top cover in Sahara  
Structure and doors in Extra clear transparent glass  
with back in MarmoReflex Sahara  
100 x 50 x 150 h





# MUSA MADIA

Design · GianMarco Codato & Luciano Trevisiol



R

Detail in Bronze 100M finish and  
MarmoReflex Onice Bianco ◀

Wooden structure covered in ▶  
MarmoReflex Grey St. Laurent  
Handle details and metal base  
in Bronze 100M finish  
80 x 40 x 175 h



MADIE  
CLIPBOARDS



# MUSA MADIA

Design · GianMarco Codato & Luciano Trevisiol



R

Detail in Bronze 100M finish and  
LegnoReflex Ebano chiaro  
Custom glass shelf inside with bottle holder

Wooden structure covered in  
LegnoReflex Ebano chiaro  
Handle details and metal base  
in Bronze 100M finish  
80 x 40 x 175 h



R



# QUARTZ MADIA

Design · Riccardo Lucatello



Doors detail ◀

Wooden structure in Sunbronze 110M finish ▶  
Legs in transparent glass  
120 x 56 x 140 h





OH MADIA

Design · Tulczinsky



◀ Doors and flap opening detail

▶ Structure in shaped rounded wood  
in satin Brass 104M finish  
Doors covered in leather Cat. C Platino  
with Emerald quilting  
2 doors and 1 flap  
75 x 55 x 140 h





# OH MADIA

Design · Tulczinsky



◀ Doors and open space detail

▶ Structure in shaped rounded wood in satin Dark Brass 105M finish  
Doors covered in leather Nabuk Tortora with Emerald quilting  
Open space with Extra clear mirror glass on bottom  
2 doors and 1 open space  
75 x 55 x 140 h





# SAN MARCO MADIA

Design · Tulczinsky



Wooden structure in Canaletto Hennè ◀  
Doors with handles with wood detail  
Sides covered with leather Nabuk Sabbia  
Top in MarmoReflex Sahara  
with profile in satin Brass 104M finish  
2 doors, 1 flap and 1 open space  
130 x 43 x 140 h





# ONIS RECTANGULAR

Design · Tulczinsky



Detail Tree decoration ◀

Structure in Extra clear glass ▶  
with Tree decoration  
Glazed metal base and central support  
70 x 40 x 193 h





# GLASS SHOWCASE

Design · Tulczinsky · R&C Reflex



▼ 01. ONIS ROUND  
Ø 50 x 193 h

Vitrine in Extra clear curved glass  
Frosted back  
Glass Top and bottom  
Glazed metal base and central support



▼ 02. ONIS SQUARE  
45 x 45 x 193 h



▼ 03. ONIS CORNER  
55 x 70 x 193 h

R



▼ ELIPSE VETRINA  
103 x 48 x 175 h

Vitrine in curved glass  
Base in White lacquered glass  
Top in transparent glass



▼ COMPOSITA RETTANGOLARE  
90 x 40 x 175 h

Vitrine in curved glass  
Wooden base and top  
lacquered in Bronze 100M finish



▼ MEGA CORNER  
55 x 55 x 180 h

Vitrine in curved transparent glass  
Wooden base and top  
lacquered in Bronze 100M finish

R



▼ MEGA VETRINA  
144 x 45 x 180 h



*Librerie, bar e porta tv*  
**bookcases, bars and tv-stands**

Librerie / Bookcases



Aurora  
Pag. 146



Avantgarde libreria  
Pag. 188



Origami collection  
Pag. 118



Prisma libreria  
Pag. 140



Segno libreria  
Pag. 172



System 01  
Pag. 152



Tango libreria  
Pag. 138



Tango T libreria  
Pag. 128

Bar e Porta TV / Bar and TV-stand



Avantgarde bar Special  
Pag. 192



Avantgarde TV  
Pag. 184



Coco de Mer bar  
Pag. 144



Luna Hi-fi  
Pag. 180



Mirage porta TV  
Pag. 182



Movie porta TV special  
Pag. 176

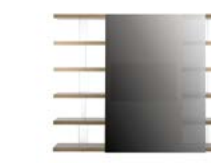

Tango libreria anta TV  
Pag. 136



Tango T libreria anta TV  
Pag. 132



# ORIGAMI

Design · R&C Reflex



Doors detail ◀

Structure in Sunbronze 110M finish ▶  
264 x 46 x 269 h





# ORIGAMI

Design · R&C Reflex



R

Structure and plinth in lacquered wood Grigio colour ◀  
Floor composition: 176 x 46 x 49 h  
Suspended composition: 220 x 46 x 176 h

Structure and plinth in Bronze 100M finish ▶  
Floor composition: 352 x 46 x 49 h  
Suspended composition sx: 132 x 46 x 132 h  
Suspended composition dx: 44 x 46 x 132 h



R



ORIGAMI

Design · R&C Reflex



Door opening detail ◀

Structure in satin Dark Brass 105M finish ▶  
132 x 46 x 176 h





# ORIGAMI

Design · R&C Reflex



► Structure in Bronze 100M finish  
Suspended composition below: 704 x 46 x 88 h  
Suspended composition above: 308 x 46 x 44 h





# ORIGAMI BIFRONTALE

Design · R&C Reflex



R

Opening doors detail in satin Brass 104M finish ◀

Structure and plinth in Bronze 100M finish ▶  
264 x 61 x 225 h



R



# TANGO T LIBRERIA

Design · R&C Reflex



Partitions detail in Bronze glass ◀

Wooden shelves in Bronze 100M finish ▶  
Partitions in Bronze glass  
220 x 36 x 174 h





# TANGO T LIBRERIA

Design · R&C Reflex



Wooden shelves in Bronze 100M finish ◀  
Partitions in Bronze glass  
93 x 36 x 40 h

Wooden shelves in Bronze 100M finish ▶  
Partitions in Bronze glass  
214 x 36 x 57,5 h





# TANGO T LIBRERIA ANTA TV

Design · R&C Reflex



Wooden shelves in Bronze 100M finish ◀  
Partitions in Bronze glass  
Sliding door in supersilver glass with metal  
frame and horizontal lycra-band for speakers  
285 x 36 x 174 h  
Tv door: 140 x 8 x 140 h





# TANGO T SPECIAL

Design · R&C Reflex



Detail: partitions in extra-clear glass ◀  
and in satin Dark Brass 105M finish

Wooden shelves in satin Dark Brass 105M finish ▶  
Partitions in Extra clear glass and  
in satin Dark Brass 105M finish  
Sliding door in supersilver glass with metal  
frame and horizontal lycra-band for speakers  
Custom 285 x 44 x 245 h  
Custom tv door: 126 x 6,6 x 110 h





# TANGO LIBRERIA ANTA TV

Design · R&C Reflex

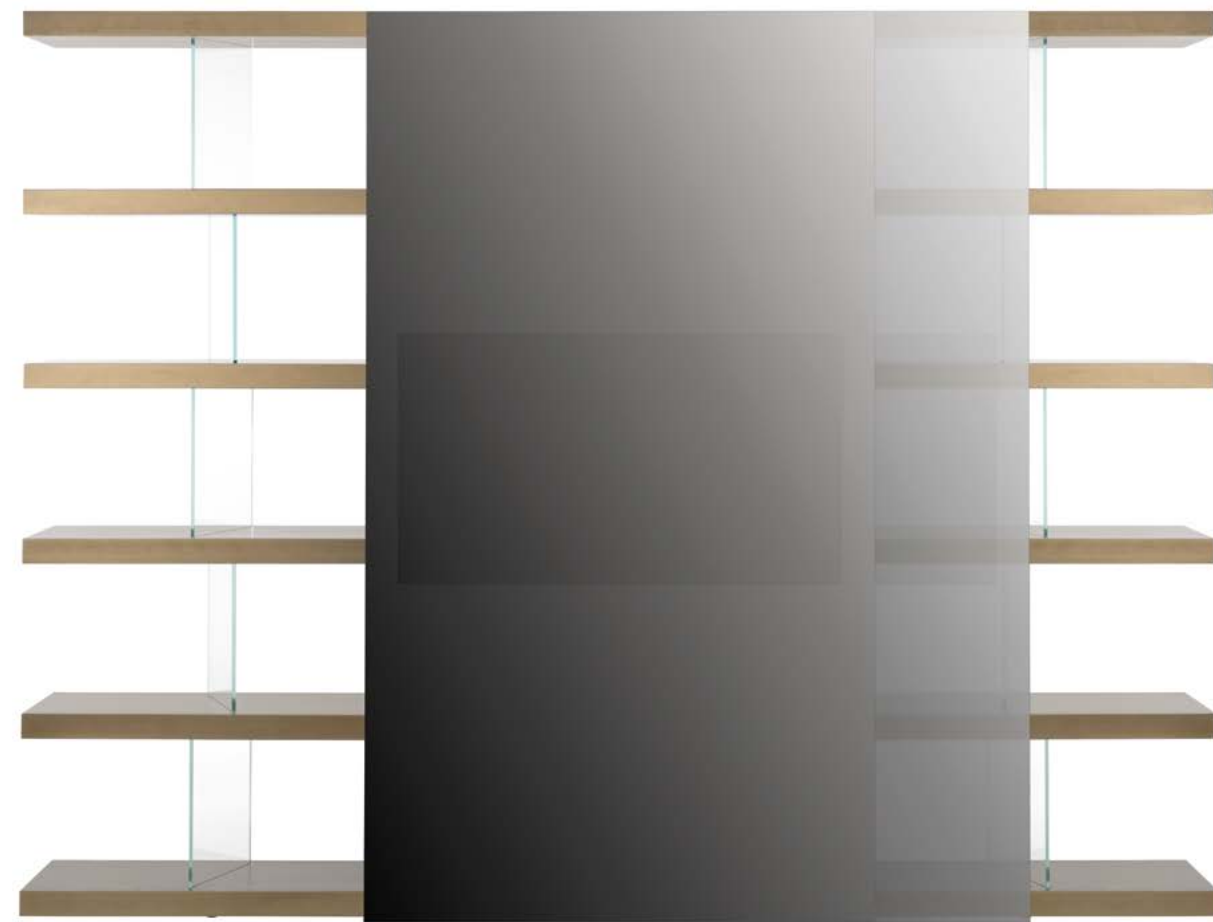

Wooden shelves in satin Brass 104M finish ◀  
Partitions in Extra clear glass  
Sliding door in Supersilver glass  
285 x 46 x 216 h  
Tv door: 120 x 10 x 214 h





# TANGO LIBRERIA

Design · R&C Reflex



Partitions detail in Extra-clear glass ◀

Wooden shelves in satin Brass 104M finish ▶  
Partitions in Extra clear glass  
285 x 36 x 216 h

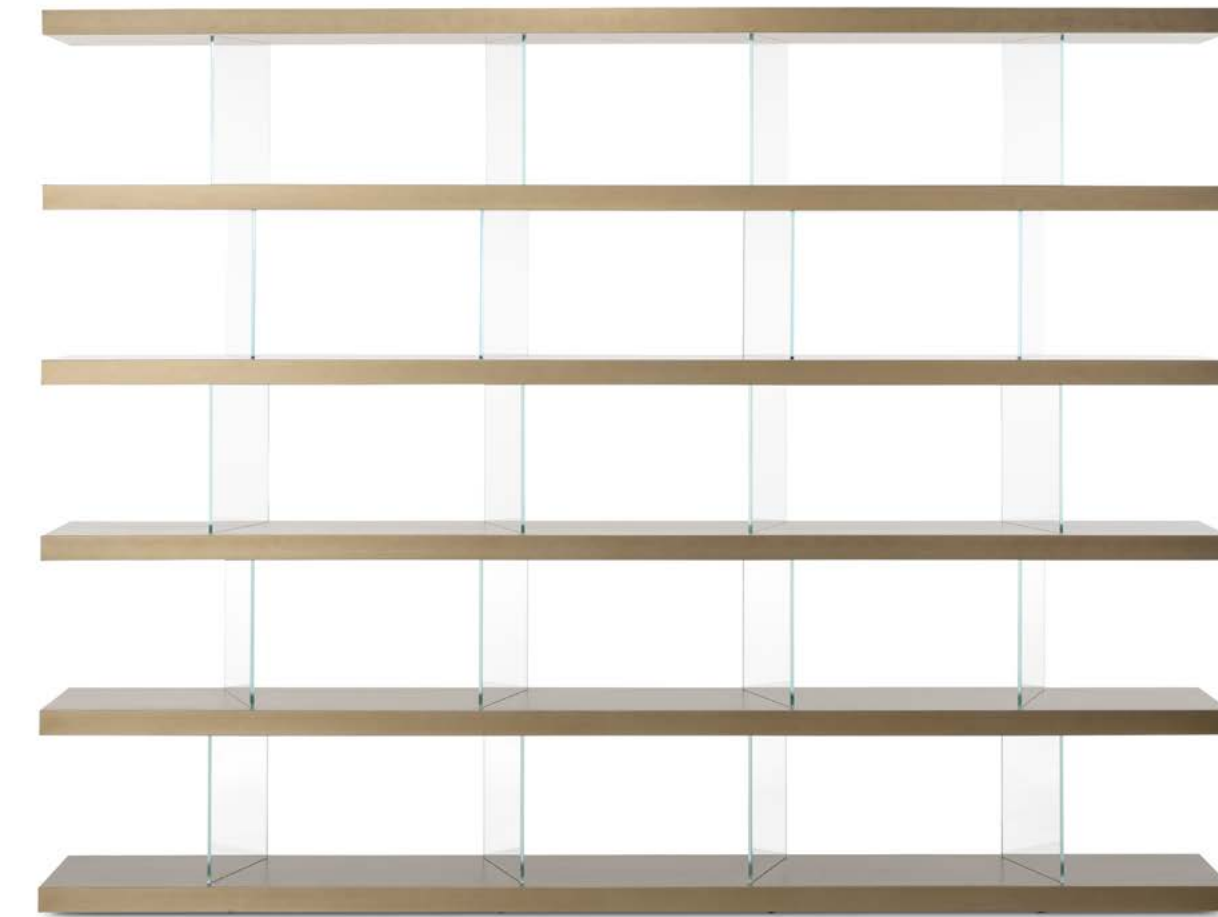



# PRISMA LIBRERIA

Design · Riccardo Lucatello



Shelves in Canaletto Walnut ◀  
Metal divisions in satin Brass 104M finish  
Special - 240 x 36 x 175 h

Shelves in Sunbronze 110M finish ▶  
Metal divisions in Sunbronze 110M finish  
Special - 480 x 36 x 175 h





# PRISMA LIBRERIA

Design · Riccardo Lucatello



Partitions detail in satin Brass 104M finish ◀

Shelves in lacquered wood Bordeaux colour ▶  
Metal divisions in satin Brass 104M finish  
240 x 36 x 175 h



R



# COCO DE MER BAR

Design · Riccardo Lucatello



Shaped bar detail in lacquered ◀  
Bianco Venezia finish

Shaped bar lacquered in ▶  
Bianco Venezia finish  
Top in etched lacquered glass  
150 x 60 x 116 h





# AURORA CANTINA VINI

Design - Tulczinsky



R

Back in MarmoReflex Sahara ◀  
Shelves in Extra clear glass  
63 x 24 x 200 h

Back in MarmoReflex Sahara ▶  
Shelves in Extra clear glass



R



# AURORA CANTINA VINI

Design - Tulczinsky

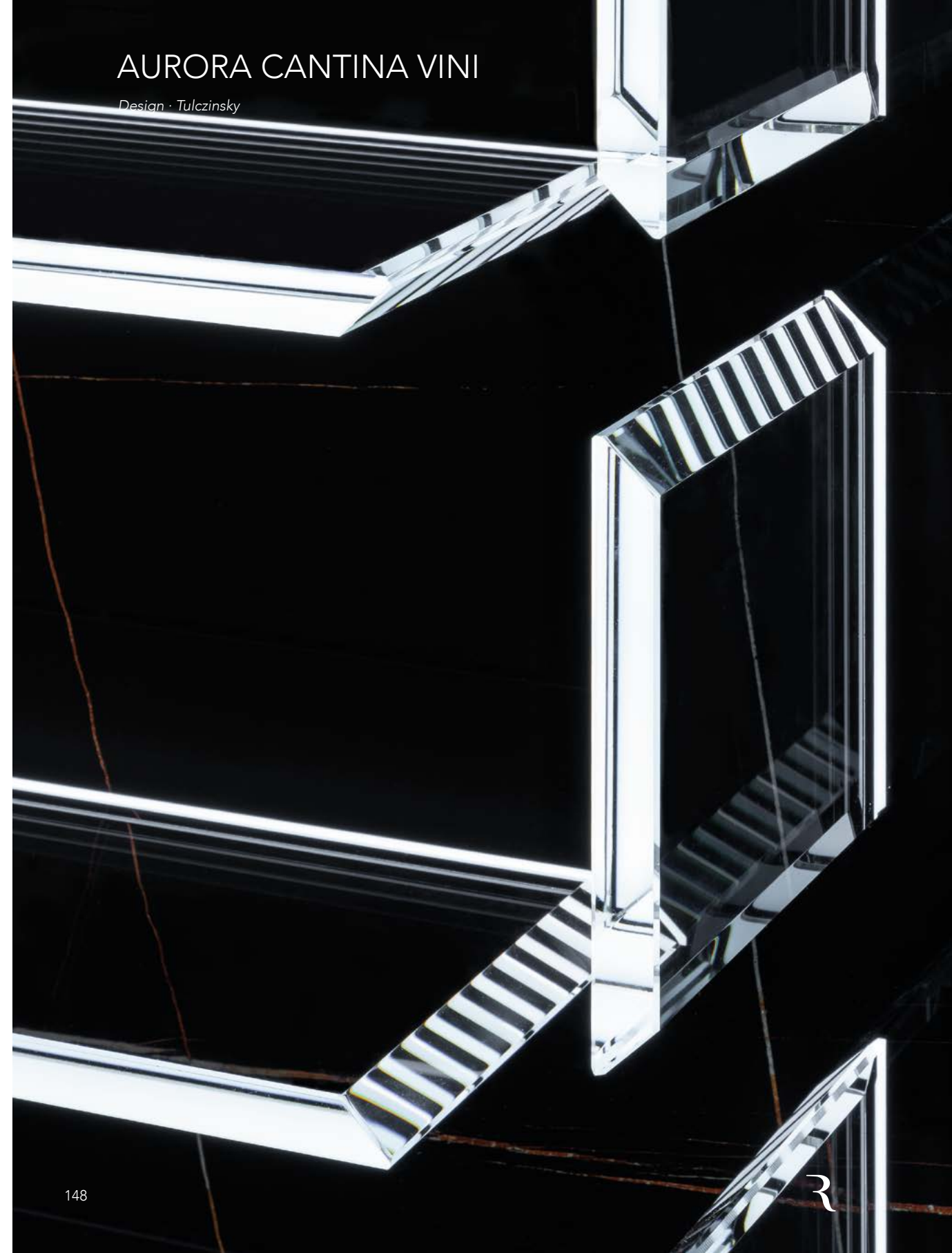

Back in MarmoReflex Sahara ◀  
Shelves in Extra clear glass

Back in MarmoReflex Sahara ▶  
Shelves in Extra clear glass  
317 x 24 x 270 h





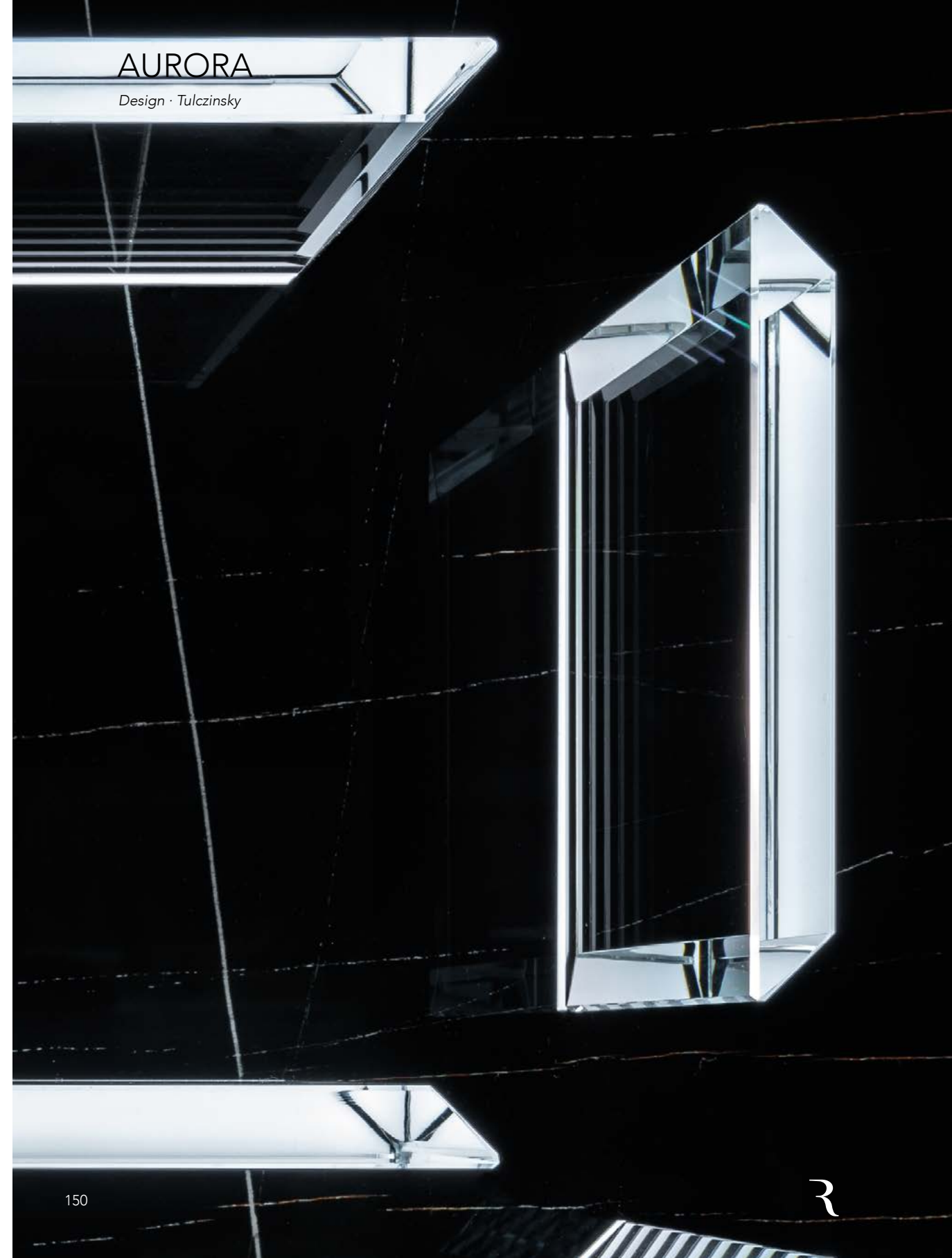

AURORA

Design · Tulczinsky



Back in MarmoReflex Sahara ◀  
Shelves in Extra clear glass

Back in Bronze 100M finish ▶  
Shelves in Extra clear glass  
339 x 24 x 270 h





stella nudo

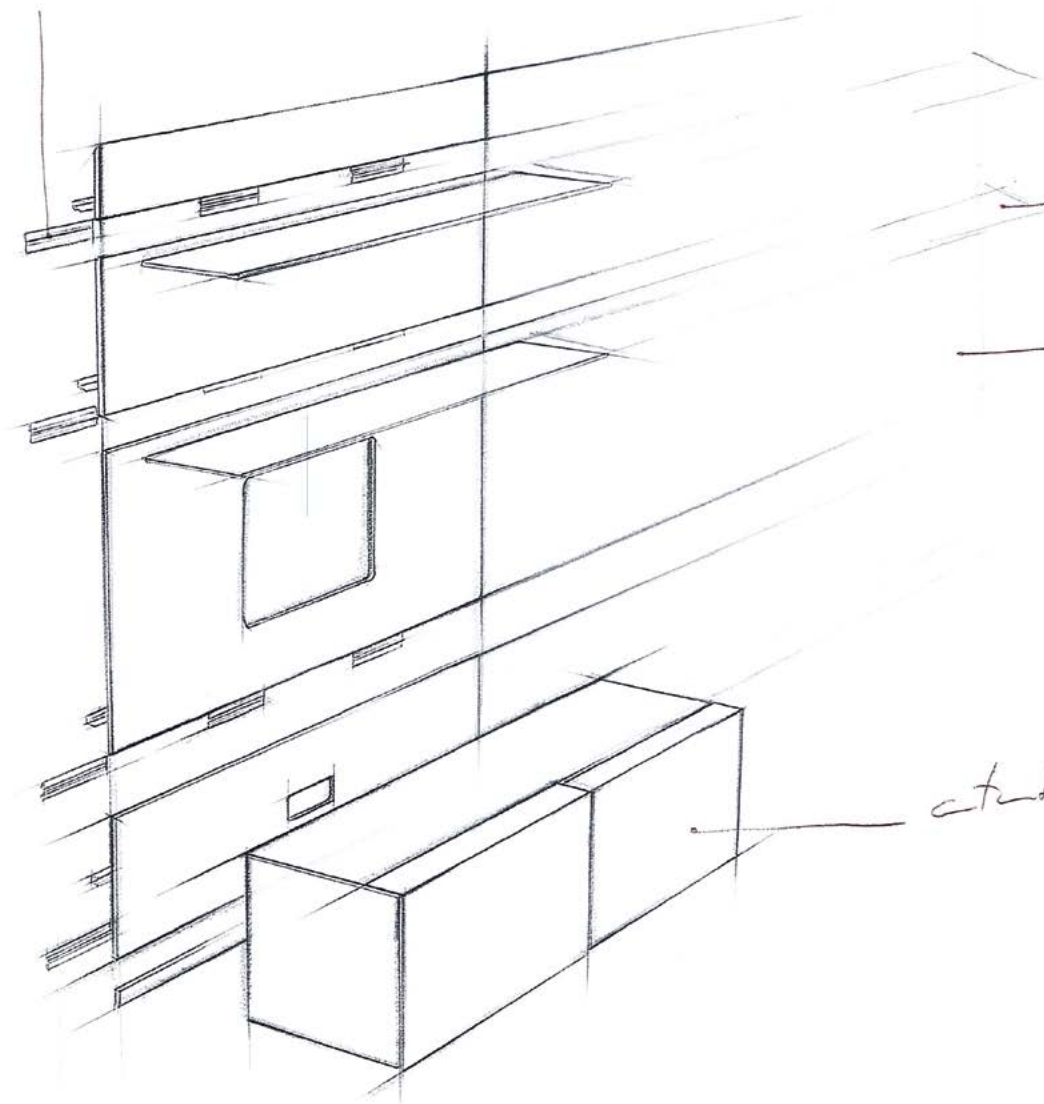

super a rete

pendente  
boiserie

cassa

System 01  
2020

# SYSTEM

## 01

Reflex introduce un nuovo modo di concepire gli spazi della casa, non solo prodotti singoli ognuno con il proprio carattere, bensì più prodotti integrati per creare ambienti più complessi per il vivere quotidiano.

System 01 è il primo sistema flessibile Reflex in cui si integrano boiserie, mensole e contenitori. Le diverse modularità in altezza e larghezza permettono libertà progettuali e compositive e creano un nuovo prodotto d'arredo dai tratti netti e fortemente contemporanei.

*Reflex presents a new way of conceiving the spaces of the house, not only individual products each with its own character, but more integrated products to create more complex environments for everyday life.*

*System 01 is the first Reflex modular wall system, where wall boiserie, shelves and containers are integrated. The various modularities in height and width allow design and compositional freedom and creates a new product with a distinctive and contemporary features.*



# SYSTEM 01

Design · R&C Reflex

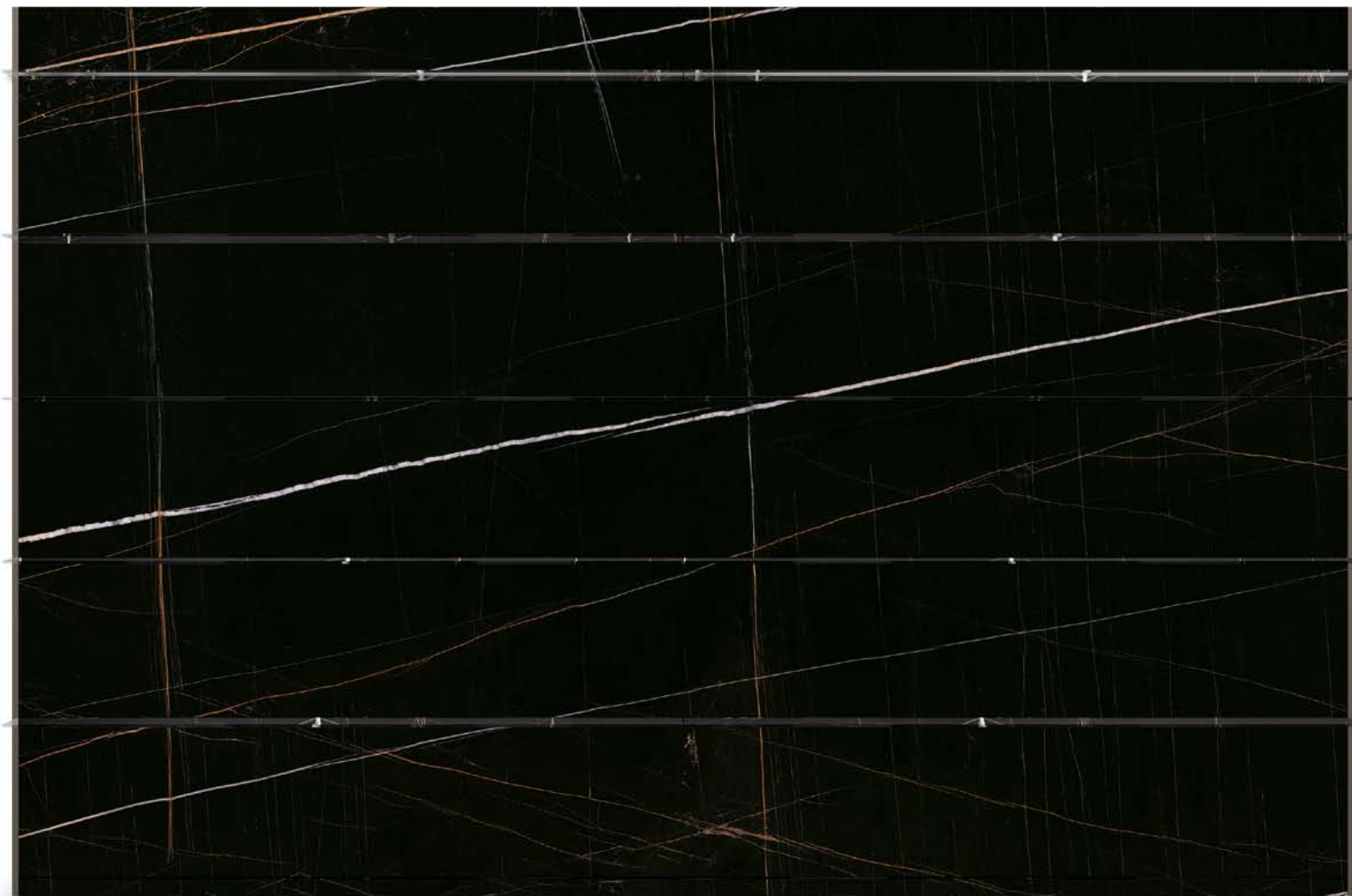

Boiserie in MarmoReflex Sahara ◀  
Shelves in Smoke-grey glass  
280 x 35 x 268 h

Boiserie in MarmoReflex Onice Bianco ▶  
Shelves in Bronze glass  
280 x 35 x 268 h





# SYSTEM 01

Design · R&C Reflex

► Boiserie in MarmoReflex Calacatta Oro and in shiny lacquered glass Fumo colour  
Mirage buffet low in MarmoReflex Calacatta Oro  
Shelves in Smoke-grey glass  
600 x 58 x 220 h





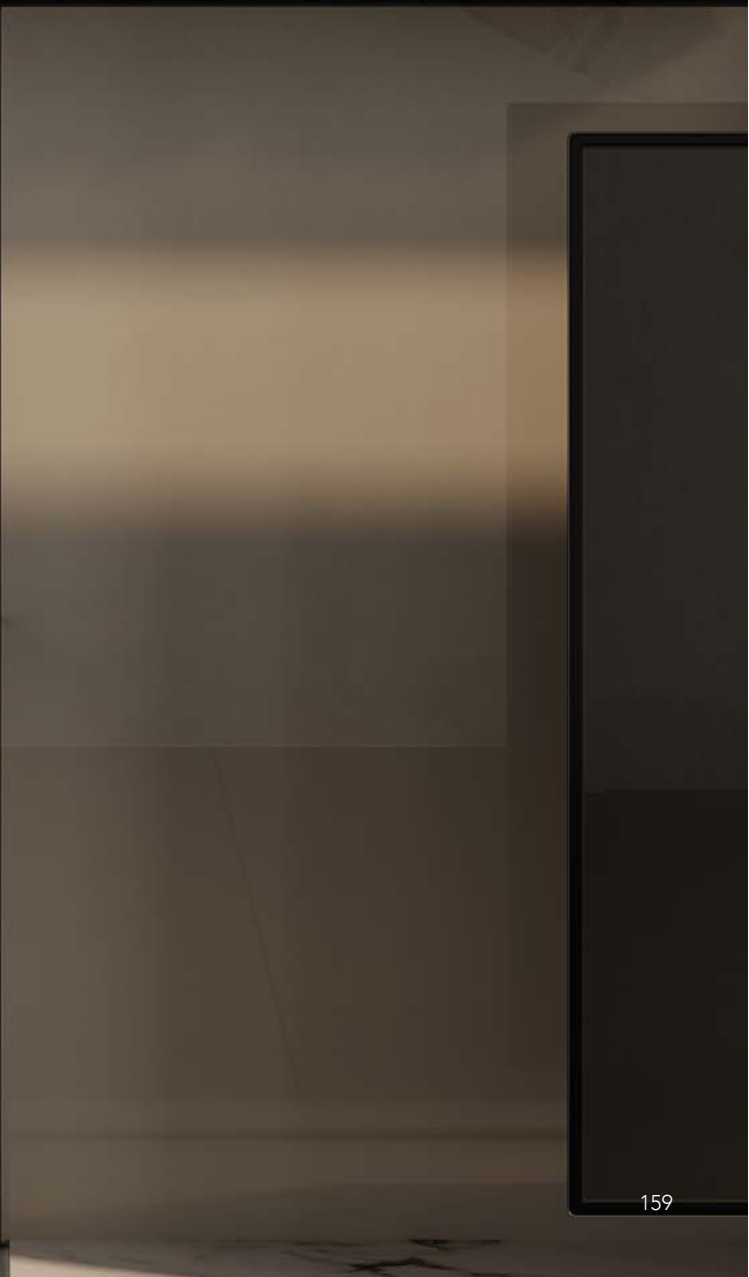

Boiserie in MarmoReflex Calacatta Oro and  
in shiny lacquered glass Fumo colour  
Shelves in Smoke-grey glass



# SYSTEM 01

Design R&C Reflex



► Boiserie in MarmoReflex Amani Grigio and in shiny lacquered glass Fumo colour  
Mirage buffet low in shiny lacquered glass Fumo colour  
Shelves in Bronze glass  
800 x 58 x 220 h



# SYSTEM 01

Design · R&C Reflex



Boiserie in MarmoReflex Amani Grigio and in shiny lacquered glass Fumo colour  
Mirage buffet low in shiny lacquered glass Fumo colour  
Shelves in Bronze glass





# SYSTEM 01

Design · R&C Reflex



Boiserie in Extra clear mirror glass ◀  
Monolite buffet in etched  
glass Hennè colour  
Shelf in Bronze glass  
220 x 45 x 172 h

Boiserie in Extra clear mirror glass ▶  
Monolite buffet in LegnoReflex Ebano chiaro  
Shelf in Bronze glass  
220 x 45 x 172 h





# SYSTEM 01

Design · R&C Reflex



Boiserie in MarmoReflex Amani Daino finish ◀  
Monolite buffet low in MarmoReflex Amani Daino  
Shelves in Smoke-grey glass  
Movie tv mirror in Supersilver glass  
420 x 47 x 215 h





# SYSTEM 01

Design · R&C Reflex

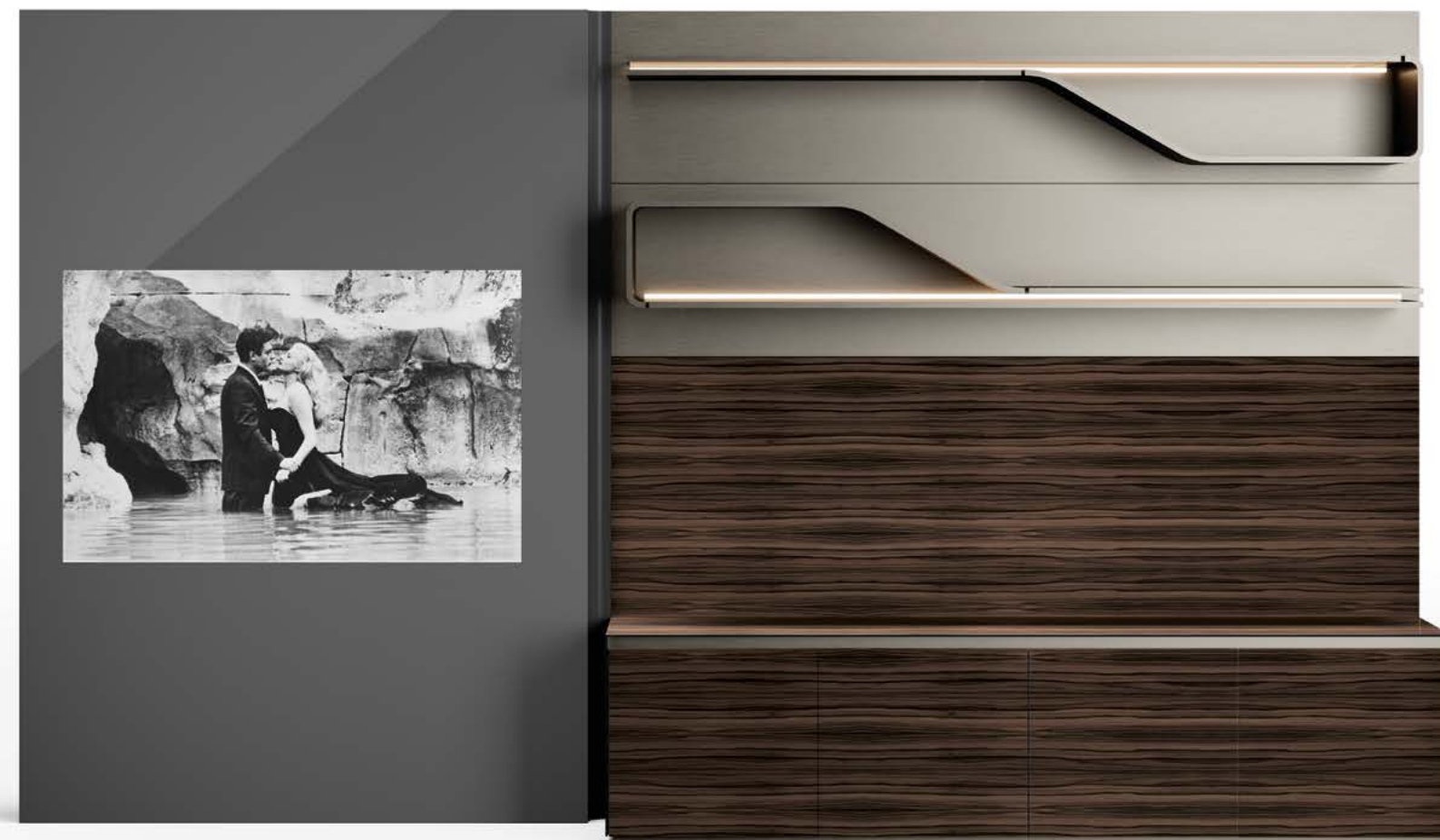

Boiserie in LegnoReflex Ebano chiaro ◀  
Monolite buffet low in LegnoReflex Ebano chiaro  
Segno shelves in Bronze 100M finish  
Movie tv mirror in Supersilver glass  
380 x 47 x 220 h

R



R



# SYSTEM 01

Design · R&C Reflex



► Boiserie in MarmoReflex Calacatta Oro  
Oh buffet low in satin Brass finish with doors covered in leather  
Cat. C platino with Emerald quilting  
Segno shelves in satin Brass 104M finish with MarmoReflex back  
500 x 60 x 250 h



# SEGNO LIBRERIA

Design · *pininfarina*



Shelf detail in Dark Brass 105M finish ◀

Shelves in satin Dark Brass 105M finish ▶  
Backs in lacquered wood Fumo colour  
190 x 36 x 110 h





# SEGNO LIBRERIA

Design · *pininfarina*



Shelves and backs in Canaletto Henné ◀  
Movie tv mirror in Supersilver glass  
350 x 36 x 220 h

Shelves in satin Brass 104M finish ▶  
Back in lacquered wood Fumo colour  
380 x 36 x 110 h





MOVIE PORTA TV SPECIAL

Design · *pininfarina*



Supersilver glass door detail ◀

Shelf and plinth in Canaletto Walnut ▶  
Back in matt lacquered wood Hennè colour  
Movie tv in Supersilver mirror glass  
Door in Supersilver glass  
220 x 37 x 220 h





# MOVIE PORTA TV SPECIAL

Design - *pininfarina*



Shelf detail in Canaletto Walnut and back  
in matt lacquered wood Hennè colour ◀

Shelf and plinth in satin Brass 104M finish ▶  
Back in matt lacquered wood Fumo colour  
Movie tv in Supersilver mirror glass  
220 x 37 x 220 h





# LUNA HI-FI

Design · Riccardo Lucatello

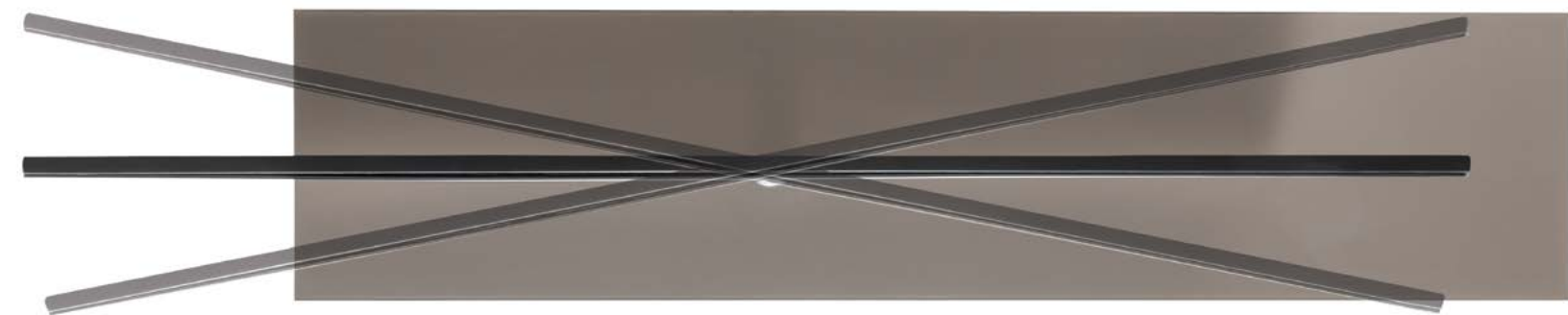

Structure covered in lacquered glass Fumo colour ◀  
TV-support on left side, rotating with motor and remote-control  
200 x 50 x 43 h

Structure covered in MarmoReflex Azul Macaubas ▶  
Central TV-support, rotating with motor and remote-control  
200 x 50 x 43 h





# MIRAGE PORTA TV

Design · R&C Reflex



Swivel TV-stand with round metal base ◀  
in brushed steel finish  
Door in dark-grey glass with black serigraphy  
Back in mirror glass  
150 x 25 x 180 h





# AVANTGARDE TV

Design · R&C Reflex



TV-unit with structure in shiny  
lacquered wood Fumo colour  
Bevelled lacquered glass applications  
in the same finish of the structure  
Back in MarmoReflex Amani Daino  
2 small and 1 long glass shelves  
183 x 45 x 217 h





# AVANTGARDE TV

Design · R&C Reflex



▶ TV-unit with structure in shiny lacquered wood Latte colour  
Bevelled lacquered glass applications in the same finish of the structure  
Back in MarmoReflex Azul Macaubas  
431 x 45 x 217 h



# AVANTGARDE LIBRERIA

Design · R&C Reflex



◀ Structure in shiny lacquered wood Fumo colour with application of bevelled lacquered glass on the fronts  
Back in MarmoReflex Onice Bianco  
298 x 35 x 217 h

▶ Structure in shiny lacquered wood Fumo colour with application of bevelled lacquered glass on the fronts  
Doors in same colour as the structure  
Back in glass with custom Dune pattern  
306 x 35 x 217 h





# AVANTGARDE LIBRERIA

Design · R&C Reflex

► Structure in shiny lacquered wood Fumo colour with application of bevelled lacquered glass on the fronts  
Doors in same colour as the structure  
Back in glass with custom Dune pattern  
Composition dx: 306 x 35 x 217 h  
Composition sx: 182 x 35 x 217 h



# AVANTGARDE BAR SPECIAL

Design · R&C Reflex

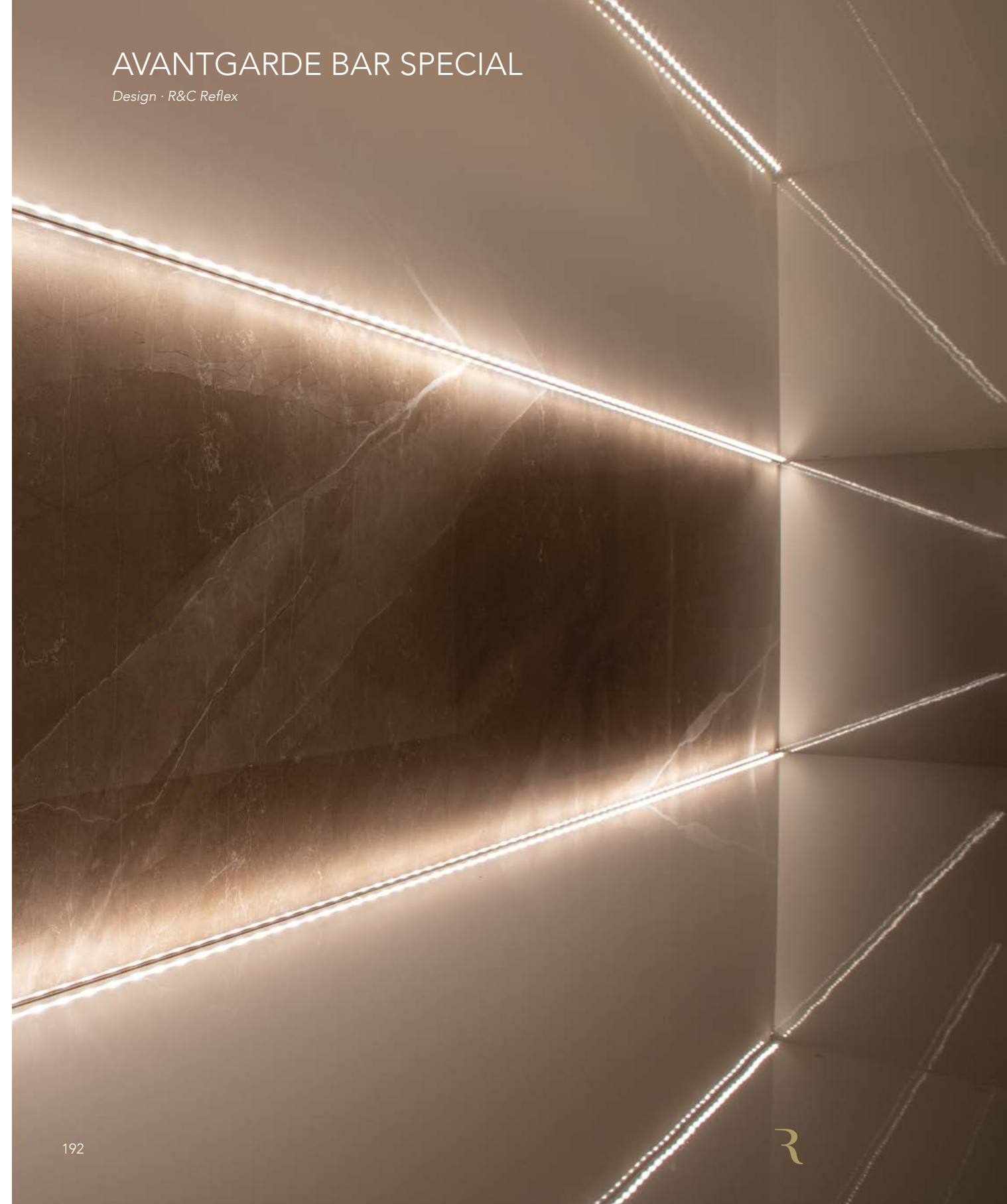

Back detail in MarmoReflex Amani daino ◀  
with Led lighting system

Structure composed by: ▶  
Counter in Vienna pattern glass  
Platform covered by lacquered glass Fumo  
Shelves-unit with 2 shelves in shiny  
lacquered finish Fumo colour with  
applications of bevelled lacquered glass  
Back in MarmoReflex Amani Daino  
240 x 142 x 217 h





*Specchi*  
mirrors

Specchi / Mirrors



Elisa Specchio  
Pag. 238



Impact specchio  
Pag. 196



Impact supersilver  
Pag. 244



Luce specchio  
Pag. 240



Mondrian specchio  
Pag. 210



Nautilus specchio  
Pag. 206



Oh frame specchio  
Pag. 224



Prisma specchio  
Pag. 218



Quartz specchio  
Pag. 220



Seventy specchio  
Pag. 226



Seventy Vetro Marmo  
Pag. 230



Shelf specchio  
Pag. 234



Titanium specchio  
Pag. 200

Specchi TV / Mirrors TV



Movie porta TV  
Pag. 246



Oh frame specchio TV  
Pag. 222



Prisma specchio TV  
Pag. 214



# IMPACT SPECCHIO

Design · R&C Reflex



Decoration in Bronze 100M finish ◀

Mirror in Extra clear glass ▶  
Decoration in gold finish  
120 x 120 h





# IMPACT SPECCHIO

Design · R&C Reflex

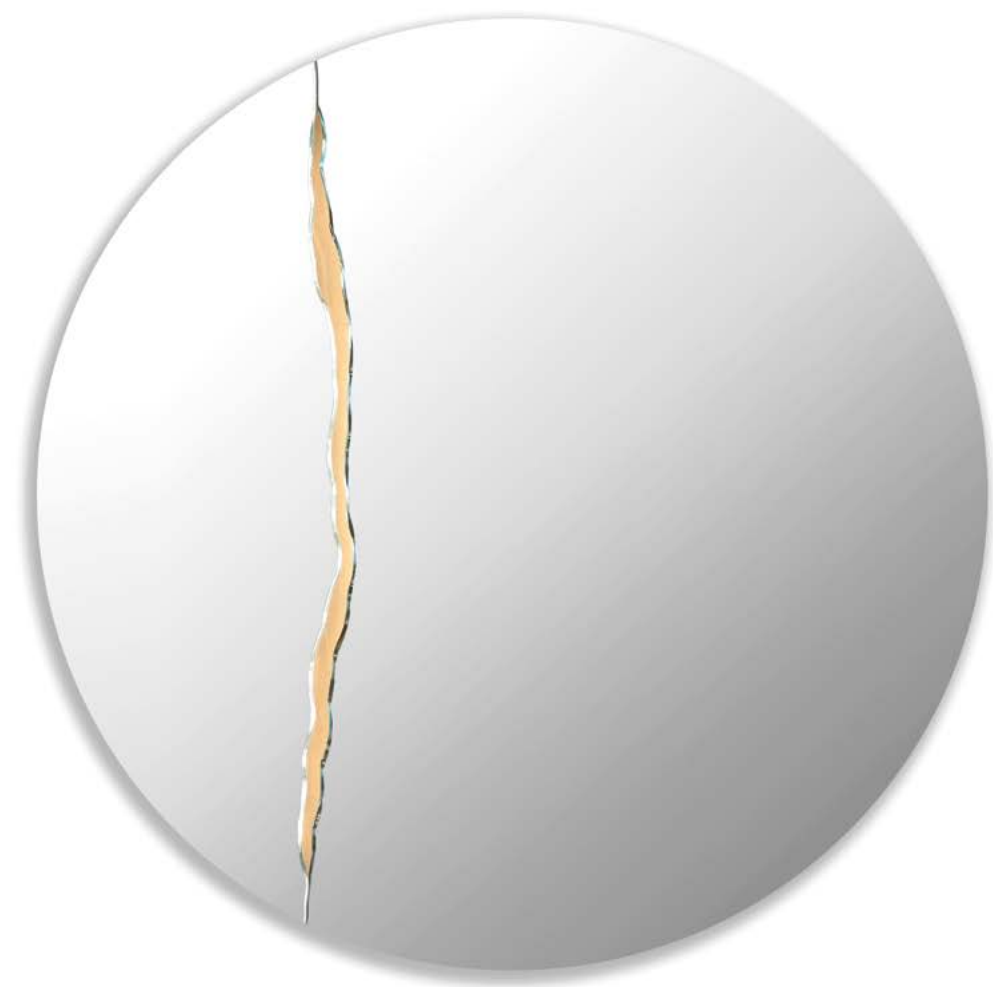

Mirror in Extra clear glass ◀  
Decoration in Gold finish  
Ø 150

Mirror in Extra clear glass ▶  
Decoration in Bronze 100M finish  
120 x 120 h





# TITANIUM SPECCHIO

Design · R&C Reflex



◀ Clock in Extra clear mirror glass  
Roman numerals in smoke-grey serigraphy  
Hands in Titanium  
Back LED Lighting  
Ø 90

▶ Clock in MarmoReflex Onice bianco  
Roman numerals in smoke-grey serigraphy  
Hands in Titanium  
Back LED Lighting  
Ø 150

R





# TITANIUM SPECCHIO

Design · R&C Reflex



◀ Clock in grey antique mirror  
Roman numerals in smoke-grey serigraphy  
Hands in Titanium  
Back LED Lighting  
Ø 120

▶ Clock in custom bronze mirror glass custom finish  
Roman numerals in smoke-grey serigraphy  
Hands in Titanium  
Back LED Lighting  
Ø 150





# TITANIUM SPECCHIO

Design · R&C Reflex



◀ Clock in Extra-clear mirror glass  
Roman numerals in smoke-grey serigraphy  
Hands in Titanium  
120 x 200 h

▶ Clock in smoked mirror glass  
Roman numerals in smoke-grey serigraphy  
Hands in Titanium  
Back LED Lighting  
120 x 200 h





# NAUTILUS SPECCHIO & OROLOGIO

Design · Tulczinsky

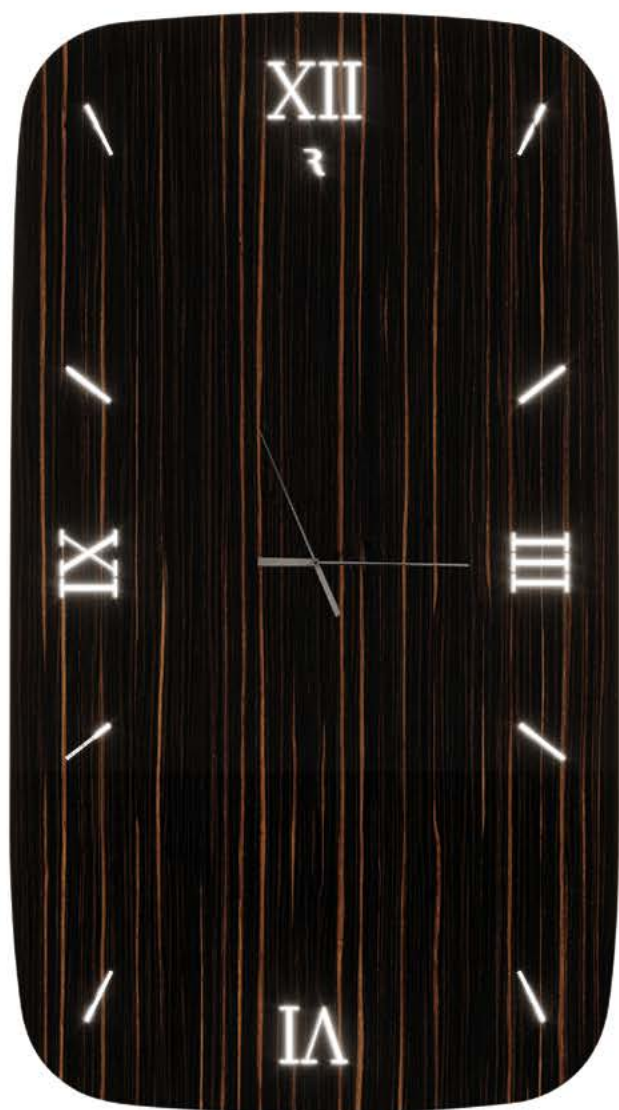

Clock in LegnoReflex Ebano scuro ◀  
Roman numerals in white sandblasted serigraphy  
Hands in Titanium  
100 x 180 h

Clock in MarmoReflex Calacatta ▶  
Roman numerals in white sandblasted serigraphy  
Hands in Titanium  
160 x 100 h



SPECCHI  
MIRRORS



# NAUTILUS SPECCHIO & OROLOGIO

Design · Tulczinsky



► Clock in MarmoReflex Sahara  
Roman numerals in white  
sandblasted serigraphy  
Hands in Titanium  
100 x 100 h

Mirror in smoked-grey glass  
100 x 100 h



# MONDRIAN SPECCHIO

Design · Emanuele Missaglia



Bevelled Extra-clear Mirror glass detail ◀

Mirror in Extra-clear mirror glass with bevel ▶  
Panel in MarmoReflex Sahara  
120 x 200 h





# MONDRIAN SPECCHIO

Design · Emanuele Missaglia



Inlay in Bronze 100M finish detail ◀

Mirror in Extra-clear mirror glass with bevel ▶  
Panel in MarmoReflex Sahara  
Inlay in Bronze 100M finish  
120 x 200 h





PRISMA SPECCHIO TV

Design · R&C Reflex

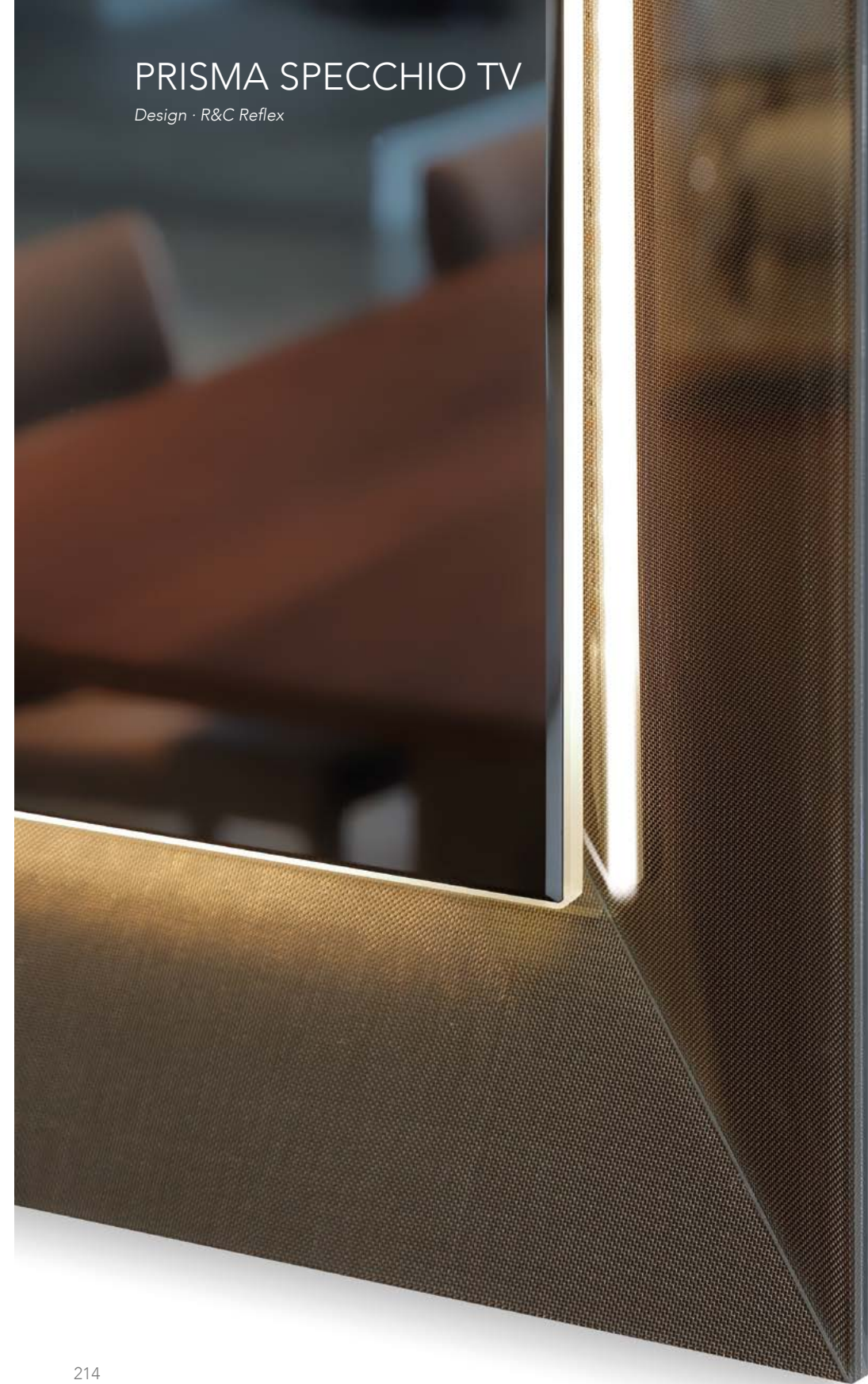

Mesh glass frame detail ◀

Mirror / TV container in Supersilver glass ▶  
Glass frame in Bronze 100M finish  
LED lighting between mirror and frame  
200 x 120 h

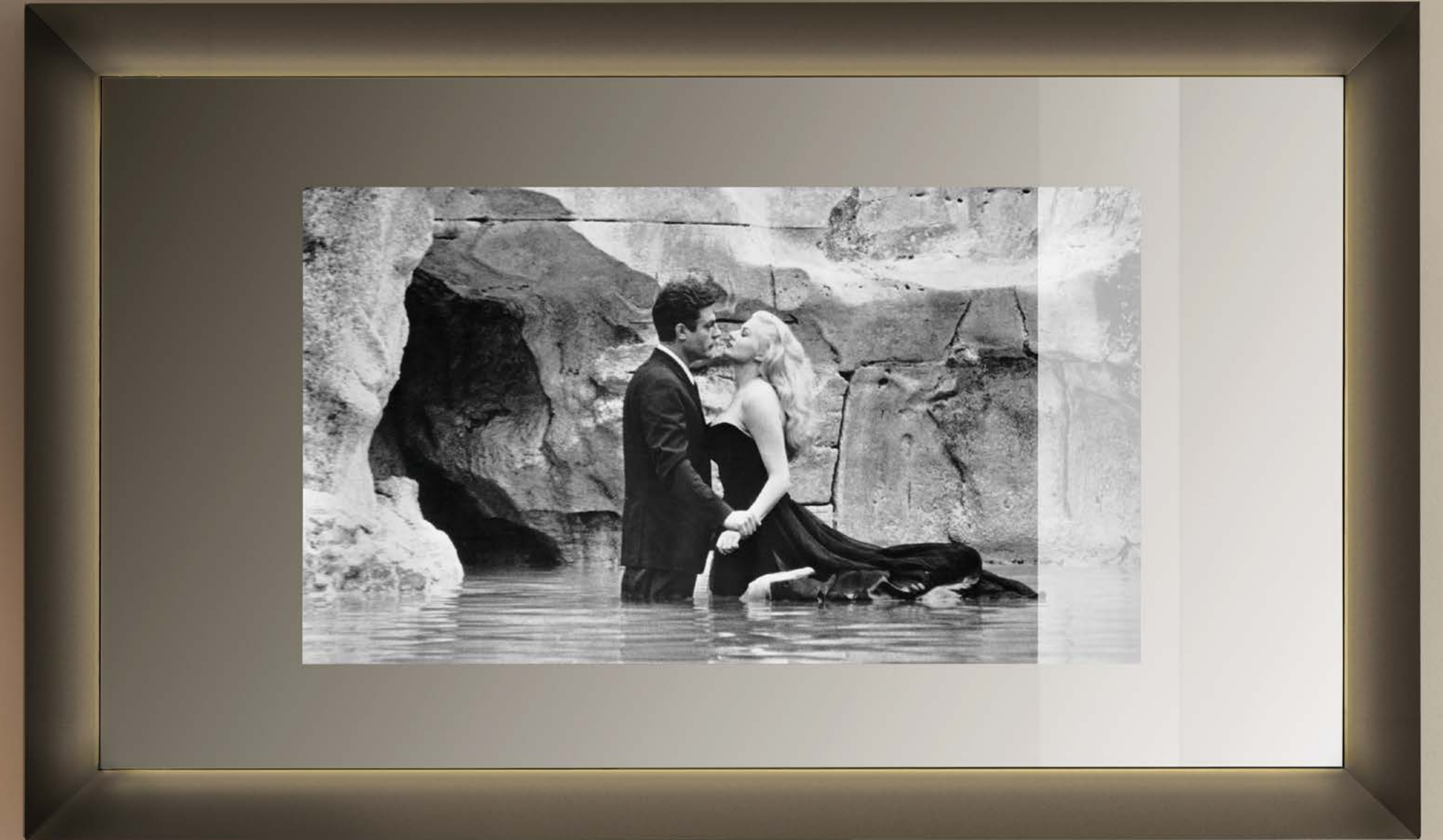



# PRISMA SPECCHIO TV

Design · R&C Reflex

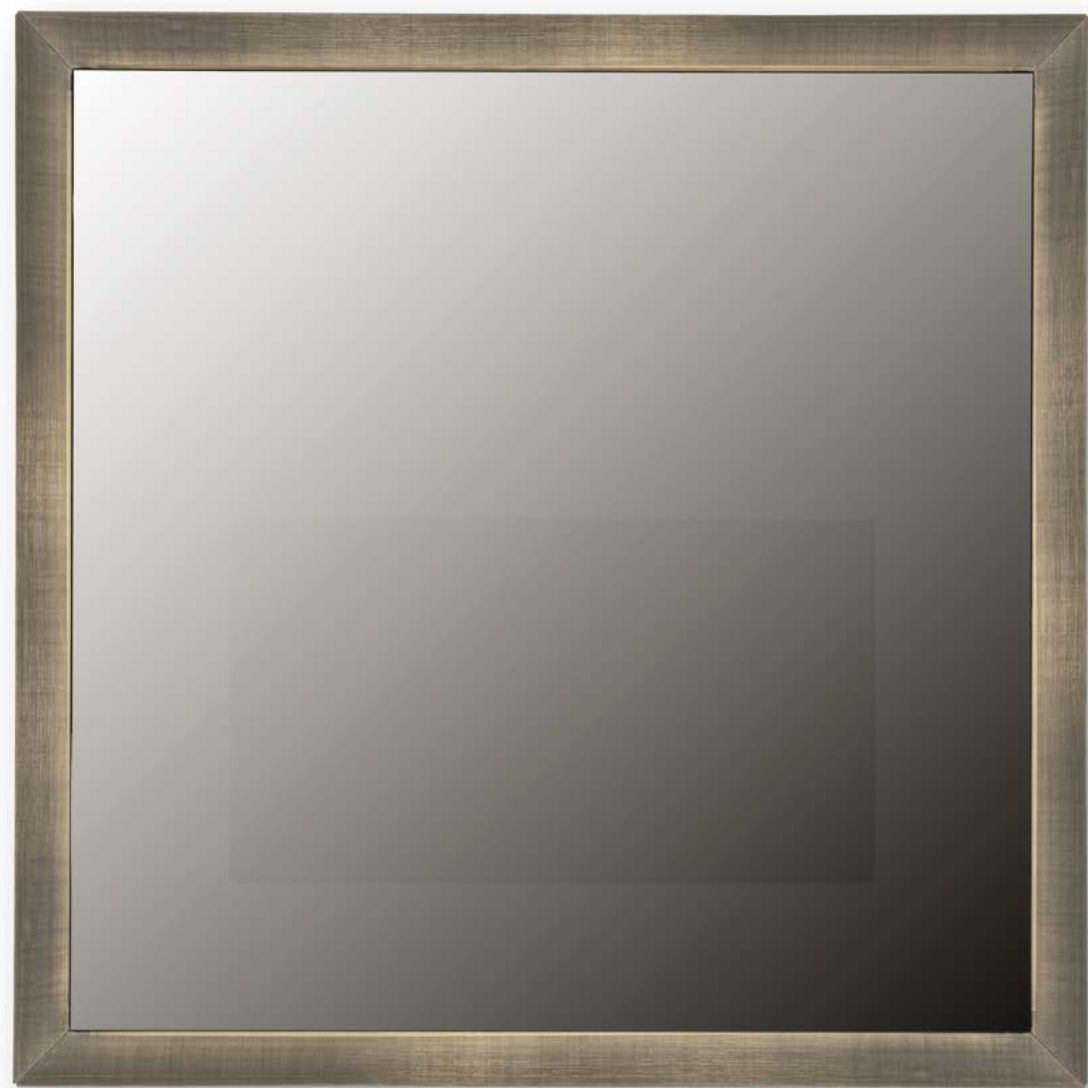

Mirror / TV container in Supersilver glass ◀  
Frame in Mesh glass  
LED lighting between mirror and frame  
200 x 200 h

Mirror / TV container in Supersilver glass ▶  
Frame in lacquered glass Verde militare colour  
200 x 200 h





# PRISMA SPECCHIO

Design · R&C Reflex

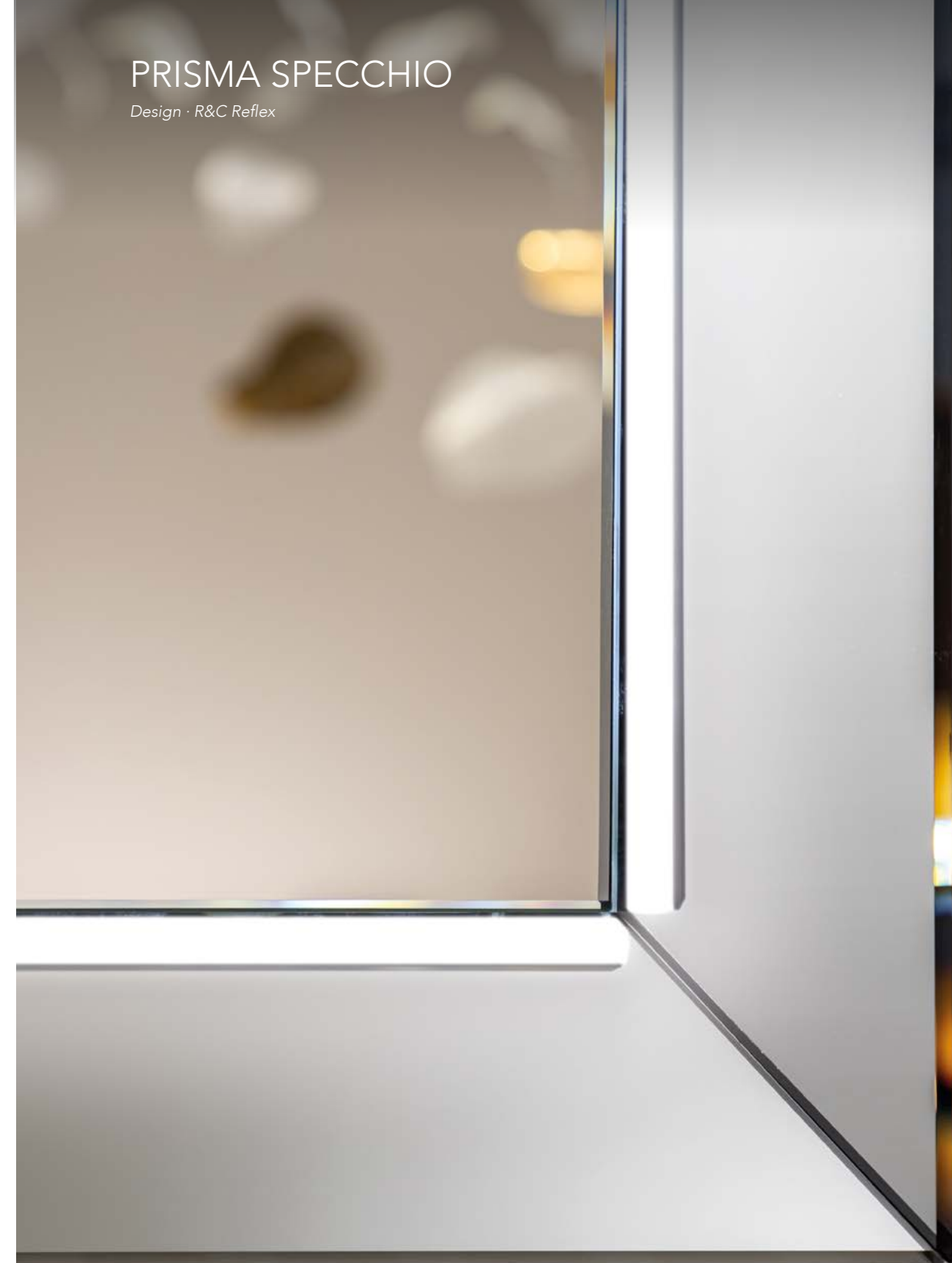

Frame in Extra clear mirror detail ◀

Mirror in Extra clear glass ▶  
Glass frame in satin Brass 104M finish  
LED lighting between mirror and frame  
200 x 120 h





# QUARTZ SPECCHIO

Design · R&C Reflex



Mirror in Extra clear glass ◀  
Frame in shiny lacquered glass  
Blu notte colour  
Irregular - 105 x 12 x 98 h

Mirror in Extra clear glass ▶  
Frame in shiny lacquered glass  
Blu notte colour  
209 x 129 h





# OH FRAME SPECCHIO TV

Design · Tulczinsky



Shaped rounded wood frame in  
satin Brass 104M finish detail ◀

Mirror / TV container in Supersilver glass ▶  
Frame in shaped rounded wood  
in satin Titanium 101M finish  
200 x 7 x 120 h





# OH FRAME SPECCHIO

Design · Tulczinsky



Shaped rounded wood frame in  
satin Dark Brass 105M finish detail ◀

Mirror in Extra clear glass ▶  
Frame in shaped rounded wood  
in satin Dark Brass 105M finish  
LED lighting between mirror and frame  
140 x 160 h





# SEVENTY SPECCHIO

Design · R&C Reflex

R

Irregular bevel detail ◀

Mirrors in Extra-clear glass ▶  
with irregular shape and bevel  
100 x 180 h



SPECCHI  
MIRRORS



# SEVENTY SPECCHIO

Design · R&C Reflex



Mirrors in Extra-clear glass ◀  
with irregular shape and bevel  
100 x 125 h

Mirrors in Extra-clear glass ▶  
with irregular shape and bevel  
120 x 120 h  
98 x 88 h  
60 x 80 h





# SEVENTY SPECCHIO VETRO MARMO

Design · R&C Reflex



Intersection detail between ◀  
MarmoReflex Grey st. Laurent panel  
and Extra clear mirror glass

1<sup>st</sup> Mirror in Extra clear glass with ▶  
irregular shape and bevel  
2<sup>nd</sup> Panel in MarmoReflex polished edges  
From left: Azul Macaubas, Sahara, Calacatta  
Oro, Agata azzurra, Orange black  
60 x 60 h  
60 x 80 h





# SEVENTY SPECCHIO VETRO MARMO

Design · R&C Reflex



Intersection detail between ◀  
MarmoReflex Onice bianco panel  
and Extra clear mirror glass

Mirror in Extra clear glass with ▶  
irregular shape and bevel  
Panel in MarmoReflex Amani Daino polished edges  
60 x 60 h  
80 x 60 h





# SHELF SPECCHIO

Design · Tulczinsky



Mirror in Bronze glass ◀  
Shelf in transparent glass  
Metal frame in Bronze 100M finish

Mirror in Bronze glass ▶  
Shelf in transparent glass  
Metal frame in custom Sunbronze 110M finish  
70 x 25 x 40 h





# SHELF SPECCHIO

Design · Tulczinsky



Mirror in Bronze glass ◀  
Shelf in transparent glass  
Metal frame in Bronze 100M finish

Mirror in Bronze glass ▶  
Shelf in transparent glass  
Metal frame in Bronze 100M finish  
70 x 25 x 180 h





# ELISA SPECCHIO

Design · R&C Reflex

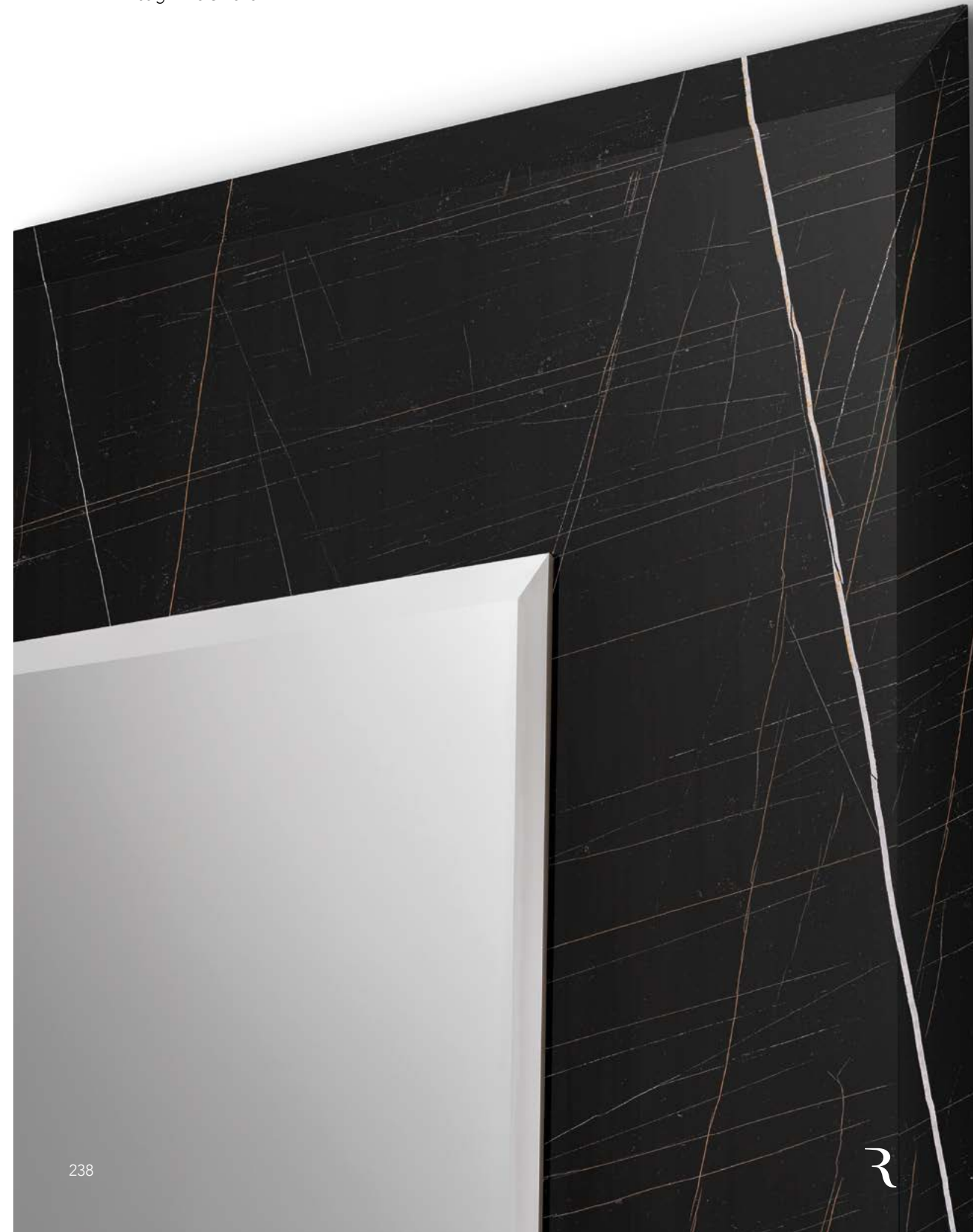

Detail in MarmoReflex Sahara ◀

Extra clear mirror glass with bevel ▶  
Frame in MarmoReflex Zebrino  
115 x 115 h





# LUCE SPECCHIO

Design · R&C Reflex



Serigraphy designs detail ◀

Extra clear mirror with serigraphy ▶  
designs and back lighting  
MODEL D - 120 x 200 h





# LUCE SPECCHIO

Design · R&C Reflex



Extra clear mirror with serigraphy designs and back lighting  
Positioned horizontally or vertically  
MODEL I - 120 x 200 h





# IMPACT SUPERSILVER SPECCHIO

Design · R&C Reflex



Frame detail in Supermirror steel ◀

Rectangular central mirror in Extra ▶  
clear mirror glass  
Frame in Supermirror steel  
Mod.B - 100 x 180 h





# MOVIE PORTA TV

Design · R&C Reflex

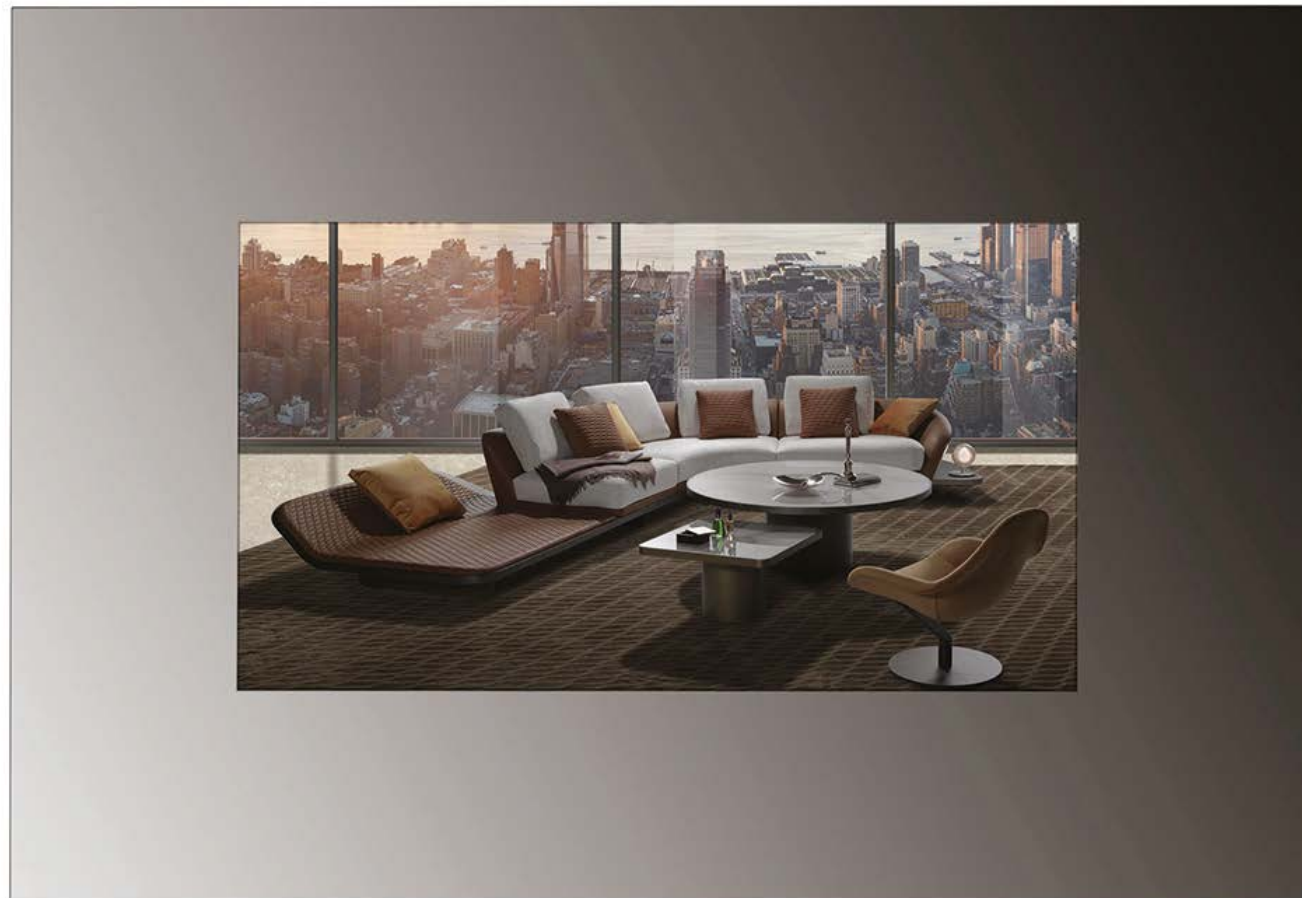

Mirror/TV container in Supersilver mirror with black serigraphy ◀  
Straight wooden frames matt lacquered henné colour  
220 x 160 h

Mirror/TV container in Supersilver mirror with black serigraphy ▶  
Straight wooden frames matt lacquered henné colour  
160 x 220 h







Avantgarde console  
Pag. 276



Avantgarde console long  
Pag. 278



Bamboo console  
Pag. 274



Cubitum console  
Pag. 264

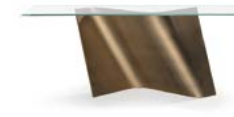

Esse console  
Pag. 252



Fili d'erba console  
Pag. 270



Foulard console  
Pag. 250



Gran canal console  
Pag. 272



Monolite console  
Pag. 262



Neolitico console vetro  
Pag. 258



Oh console  
Pag. 256



Parentesis console  
Pag. 260



Prisma steel console  
Pag. 266



Prisma steel console  
autoportante  
Pag. 268



Signore degli Anelli  
console  
Pag. 254

# Consolle console



# FOULARD CONSOLE

Design · R&C Reflex



Satin Dark Brass 105M finish detail ◀

Curved Glass in satin ▶  
Dark Brass 105M finish  
150 x 52 x 75,5 h





# ESSE CONSOLE

Design · Tulczinsky

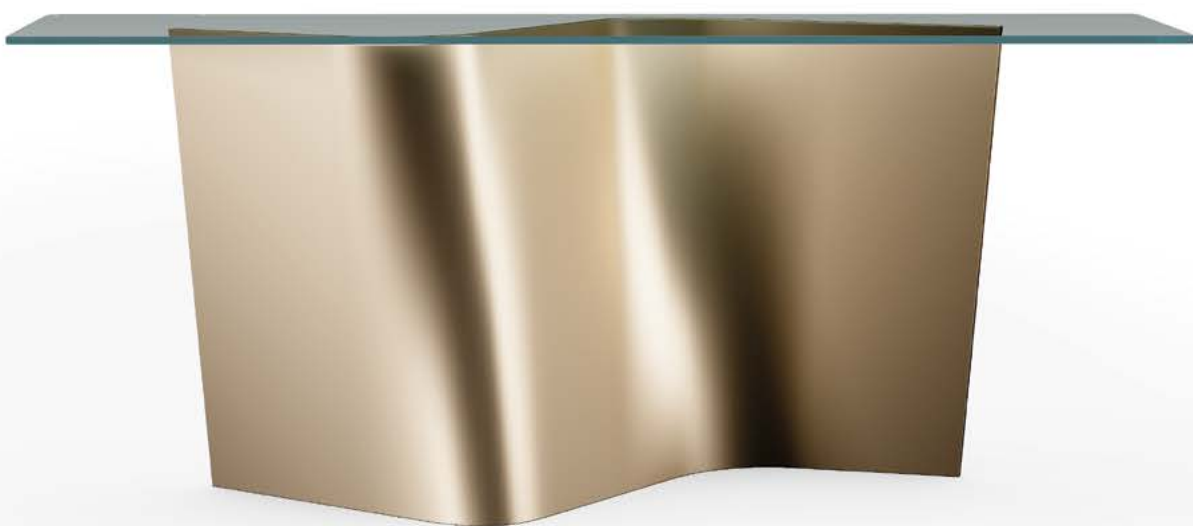

Base in curved Extra clear glass ◀  
in satin Brass 104M finish  
Glass top with polished edges  
150 x 40 x 74 h

Base in curved Extra clear glass ▶  
in Bronze 100M finish  
Custom top in MarmoReflex Onice Bianco  
150 x 40 x 74 h





# SIGNORE DEGLI ANELLI CONSOLE

Design · R&C Reflex



Base with 3 cylinders in borosilicate glass ◀  
with shaded sputtering Copper finish  
Bevel-MarmoReflex top in Amani Daino  
with edge in Bronze 100M finish  
150 x 40 x 80 h





# OH CONSOLE

Design · Tulczinsky



R

Base in satin Dark Brass 105M finish ◀  
Top in smoked glass with bevel  
100 x 30 x 76 h

Base Bronze 100M finish ▶  
Top in LegnoReflex Ebano scuro  
120 x 40 x 76 h

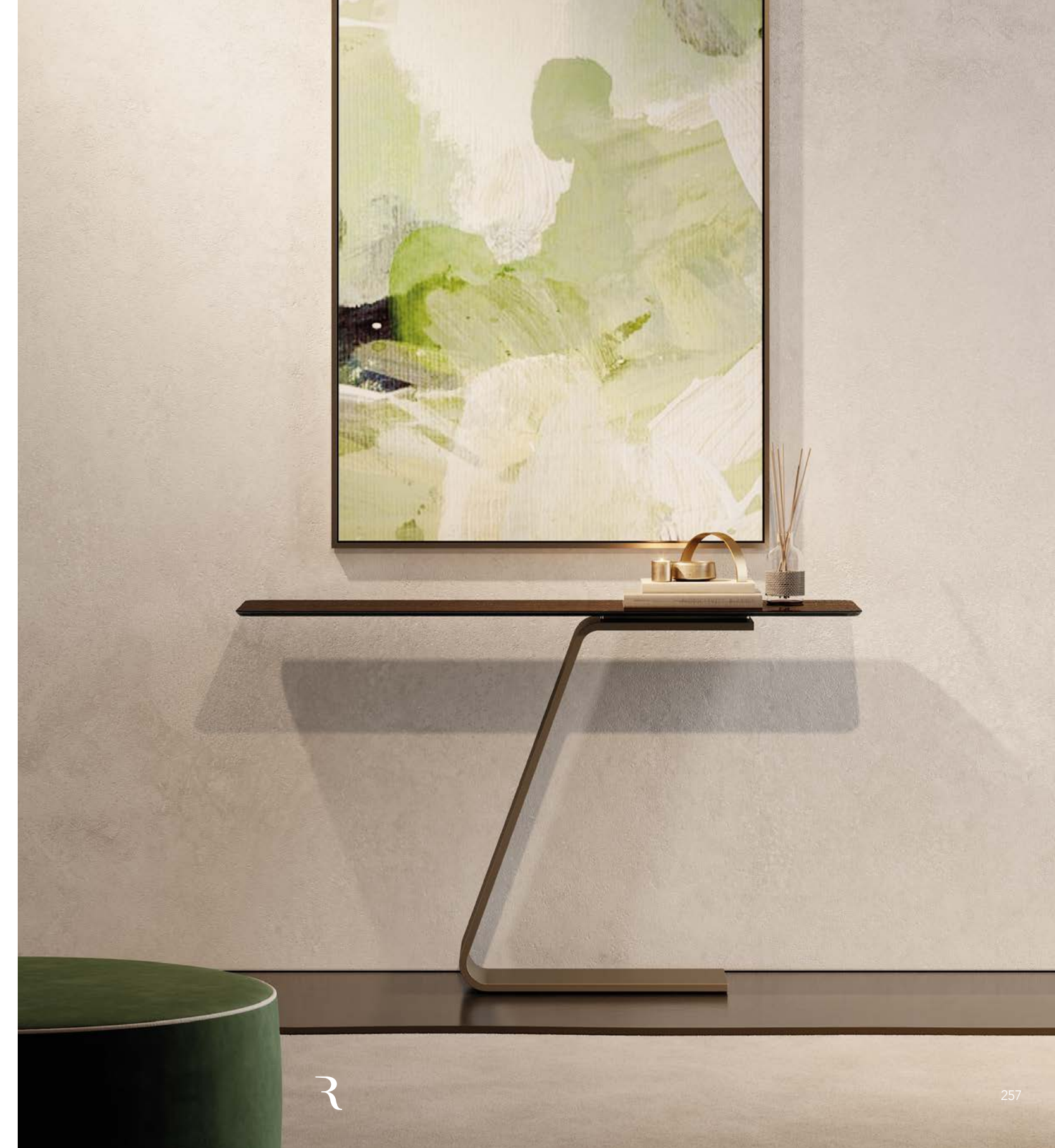

R



# NEOLITICO CONSOLE VETRO

Design · Tulczinsky



R

Detail of the curved glass ◀  
in satin Brass 104M finish

Top in transparent glass ▶  
Base in curved glass  
in satin Brass 104M finish  
150 x 50 x 75 h



R



# PARENTESIS CONSOLE

Design · Tulczinsky



Curved base detail lacquered in Brass 104M finish ◀  
Plinth in smoked mirror glass

Console with base in satin Brass 104M finish ▶  
Top in Extra clear glass with bevel  
Plinth in smoked mirror glass  
150 x 50 x 76 h





# MONOLITE CONSOLE

Design · R&C Reflex

R

Base detail in Bronze glass ◀  
with London engravings

Bevel wood top in Canaletto Hennè ▶  
Base in Bronze glass with London engravings  
150 x 40 x 80 h



R



# CUBITUM CONSOLE

Design · Riccardo Lucatello



Wooden base with edges in Bronze 100M finish ◀  
Inside: long side in Bronze mirror,  
short side in MarmoReflex Sahara  
Outside: short side in bronze mirror,  
long side in MarmoReflex Sahara  
Top in Extra clear glass lacquered in Dark Brass 105M finish  
180 x 60 x 71 h





# PRISMA STEEL CONSOLE

Design · Riccardo Lucatello



Scratchy Steel finish custom detail ◀

Metal base in custom Scratchy Steel ▶  
Bevel Wood top in custom  
matt lacquered Latte finish  
Wall fixing - 158 x 47 x 75 h





# PRISMA STEEL CONSOLE AUTOPORTANTE

Design · Riccardo Lucatello



◀ Metal base in Bronze 100M finish  
Plinth in Bronze mirror glass  
Top in Transparent glass with polished edges  
Free standing - 150 x 40 x 73 h

▶ Metal base in Dark Brass 105M finish  
Plinth in Bronze mirror glass  
Top in Transparent glass with polished edges  
Free standing - 150 x 40 x 73 h

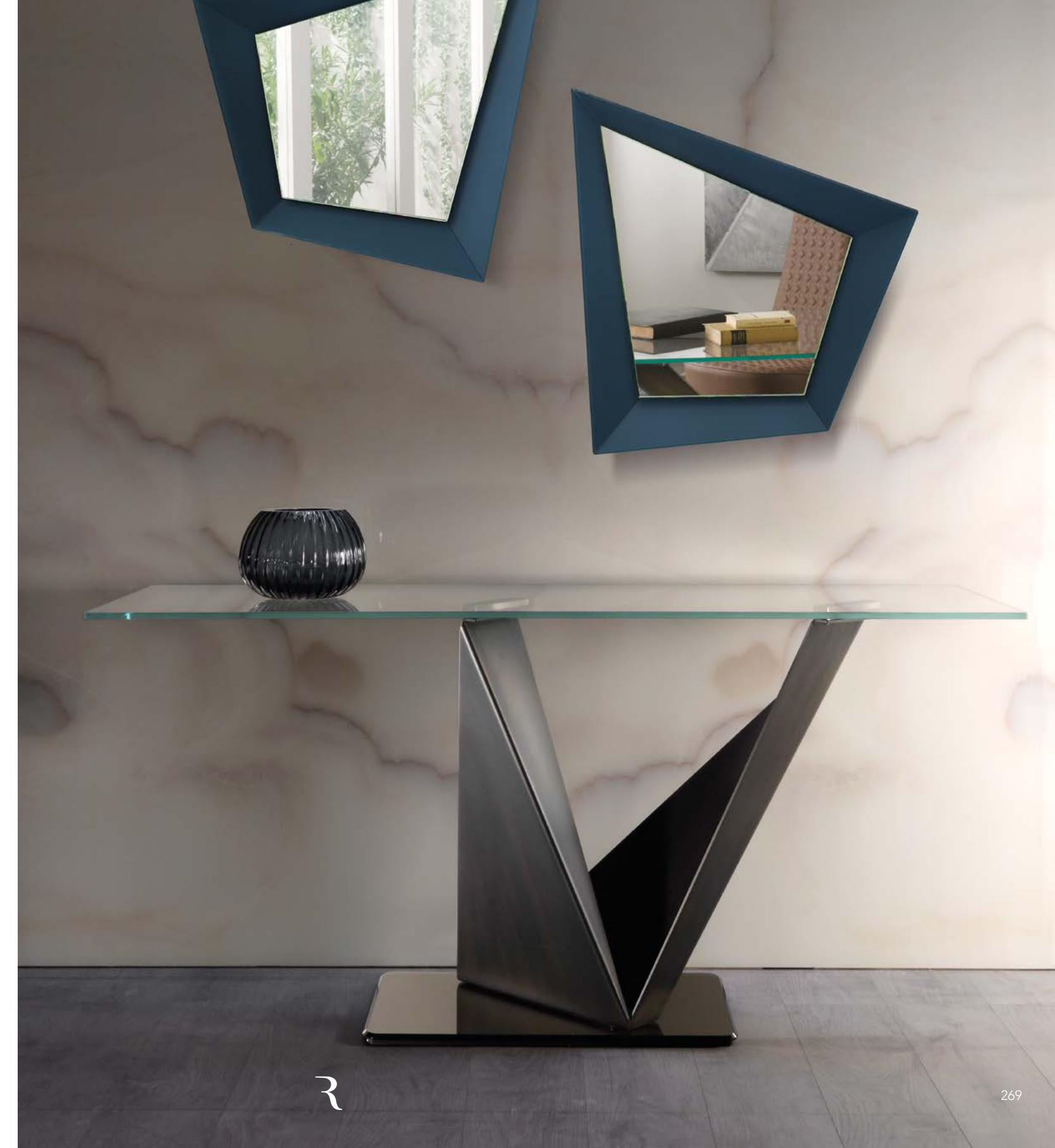



# FILI D'ERBA CONSOLE

Design · Tulczinsky

Legs attachment system REFLEX PATENT®



©MURANO

Rugiada finish detail ◀

Legs in Murano glass Rugiada finish ▶  
Top in extra-clear glass  
135 x 45 x 72 h

R



R



# GRAN CANAL CONSOLE

Design · Filipin e Berton



©MURANO

Blue-grey glass leg detail ◀

Legs in Transparent smooth Murano glass ▶  
Shaped top in Glass with bevel  
150 x 50 x 74 h

R





# BAMBOO CONSOLE

Design · Tulczinsky



## ©MURANO

Murano glass black filigreed tubes detail ◀

Base composed by Murano glass black filigreed tubes ▶  
Plinth in Smoked mirror glass  
Top in Extra clear glass with bevel  
Half-circle - 150 x 50 x 80 h





# AVANTGARDE CONSOLE

Design · R&C Reflex



Structure in shiny lacquered wood ◀  
Nero Beluga colour  
Top and fronts with application of bevelled  
lacquered glass matching the structure  
Drawer with pen holders  
140 x 38 x 100 h

Structure in shiny lacquered wood Fumo colour ▶  
Top and fronts with application of bevelled  
lacquered glass matching the structure  
Drawer with pen holders  
140 x 38 x 100 h





# AVANTGARDE CONSOLE LONG

Design · R&C Reflex



Structure in shiny lacquered wood Blu notte colour  
Top and fronts with application of bevelled lacquered glass matching the structure  
3 drawers with push-pull opening  
170 x 45,4 x 74 h

Structure in shiny lacquered wood Fumo colour  
Top and fronts with application of bevelled lacquered glass matching the structure  
3 drawers with push-pull opening  
170 x 45,4 x 74 h





Ufficio  
office

R

Scrivanie / Desks



Luce scrivania  
Pag. 290



Mach 5  
Pag. 294



Pegaso  
Pag. 288



Petalò  
Pag. 298



Prisma steel scrivania  
Pag. 292



Segno scrivania  
Pag. 286



Twist  
Pag. 296



Vele scrivania  
Pag. 282

Sedie da ufficio / Office chairs



Amet chair office  
Pag. 306



Comfort chair office  
Pag. 304



Ludwig chair office  
Pag. 302



Vela chair office  
Pag. 300



Zenith chair office  
Pag. 308

R



# VELE SCRIVANIA

Design · Riccardo Lucatello

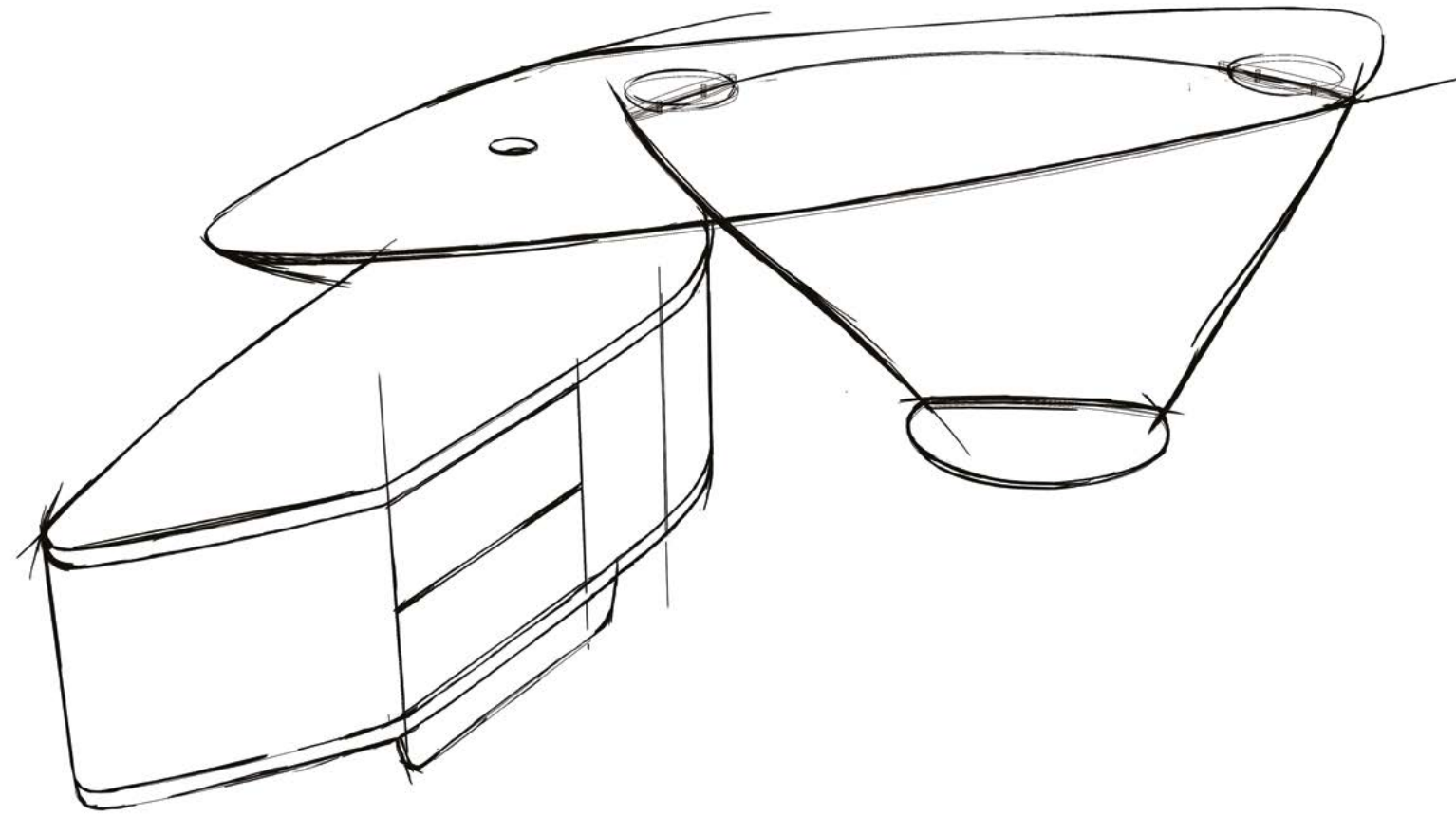

Metal base in Bronze 100M finish ▶  
Shaped top in MarmoReflex Sahara with cable-hole  
Adjustable unit with 2 drawers with structure  
in Bronze 100M finish and sides covered  
with leather Colorata Cognac  
251 x 146 x 74 h





# VELE SCRIVANIA

Design · Riccardo Lucatello



R

Metal base in Bronze 100M finish ▶  
Shaped top in MarmoReflex Sahara with cable-hole  
Adjustable unit with 2 drawers  
with structure in Bronze 100M finish and sides  
covered with leather Naturale Fumo  
251 x 146 x 74 h



R



# SEGNO SCRIVANIA

Design · *pininfarina*



Curved structure in lacquered  
Bianco Venezia finish  
Front panel and top covered in  
leather Naturale Panna  
Shaped - 250 x 98,5 x 75 h

Curved structure in satin Brass 104M finish  
Front panel and top covered in  
leather Naturale Fumo  
Shaped - 250 x 98,5 x 75 h





# PEGASO

Design · R&C Reflex



Extendable wooden top and ◀  
1 side in satin Dark Brass 105M finish  
1 side in transparent glass  
180 (240) x 90 x 75 h

Extendable wooden top and ▶  
1 side in Canaletto Hennè  
1 side in transparent glass  
180 (240) x 90 x 75 h





# LUCE SCRIVANIA

Design · R&C Reflex



1 drawer unit with partitions ◀  
in Extra clear etched glass  
with internal LED lighting  
Top and structure in shiny lacquered  
wood Fumo colour  
160 x 70 x 75 h

2 drawers unit with partitions ▶  
in Extra clear etched glass  
with internal LED lighting  
Top and structure in Canaletto Hennè  
Curved front wooden panel  
matching the structure  
220 x 90 x 75 h

R



R



# PRISMA STEEL SCRIVANIA

Design · Riccardo Lucatello



Desk with metal base in Brass 104M finish ◀  
Shaped transparent tempered glass top  
Drawers in Canaletto Hennè  
200 x 90 x 73 h

Desk with metal base in Bronze 100M finish ▶  
Bevel-LegnoReflex top in Ebano chiaro  
with fame in Bronze 100M finish  
Drawers lacquered in Bronze 100M finish  
200 x 90 x 73 h





# MACH 5

Design · R&C Reflex



Desk with base, structure and tower support in Bronze 100M finish  
Tempered shaped glass tops  
135 x 89 x 82 h





# TWIST

Design · Tulczinsky



Top covered in leather Nabuk Sabbia ◀  
Spacers and drawers in satin Brass 104M finish  
Metal legs in satin Brass 104M finish  
120 x 70 x 86 h

Top covered in leather Naturale Ghiaccio ▶  
Spacers and drawers in satin Brass 104M finish  
Metal legs in satin Brass 104M finish  
120 x 70 x 86 h





# PETALO SCRIVANIA

Design · Tulczinsky



Bases in Extra-clear curved  
glass in satin Brass 104M finishing  
Bevel-MarmoReflex top in Sahara  
with edge in Bronze 100M finish  
With drawer - 160 x 65 x 77 h





# VELA CHAIR OFFICE

Design · *pininfarina*



*R*

◀ Upholstery in leather Cat.C Testa di Moro  
Base in satin Dark Brass 105M finish with pump  
to adjust the height and wheels  
56 x 51 x 86 h  
High version - 52 x 54 x 105 h

▶ Upholstery in leather Cat.C Testa di Moro  
Base in satin Brass 104M finish with pump  
to adjust the height and wheels  
56 x 51 x 86 h



*R*



# LUDWIG CHAIR OFFICE

Design · Riccardo Lucatello



▶ Padded seat and back in leather Nabuk Sabbia ◀  
Exterior back in leather Colorata Cognac  
Base in Bronze 100M finish with wheels  
81 x 81 x 95 h



▶ Padded seat and back in leather Nabuk Tortora  
Raised fixed base with 4 spokes in Bronze 100M finish  
66 x 68 x 92 h





# COMFORT CHAIR OFFICE

Design · Riccardo Lucatello



▶ Padded seat and back in leather Nabuk Grigio Chiaro  
Raised fixed base with 4 spokes in Bronze 100M finish  
66 x 66 x 81 h

▶ Padded seat and back in leather Nabuk Bianco  
Base in Bronze 100M finish with wheels  
81 x 81 x 84 h



▶ Padded seat and back in fabric Extra Ginevra 11  
Base in Bronze 100M finish with wheels  
66 x 66 x 81 h





# AMET CHAIR OFFICE

Design · Emanuele Missaglia



Padded seat and back in leather Nabuk Bianco ◀  
External back cover in fabric Extra  
Amsterdam 38 with Emerald quilting  
Raised fixed base with 4 spokes in Bronze 100M finish  
66 x 68 x 81 h

Padded seat and back in leather Nabuk Grigio chiaro ▶  
External back cover in fabric Luxury Venezia 13 with Emerald quilting  
Base in satin Brass 104M finish with pump to adjust the height and wheels  
81 x 81 x 84 h





# ZENITH HIGH CHAIR OFFICE

Design · Marco Cocco



► Structure upholstered in fabric Extra Amsterdam 38  
Base in Bronze 100M finish with wheels  
77 x 84 x (46) 120 h





# ZENITH HIGH CHAIR OFFICE

Design · Marco Cocco



Curved shape detail in leather Cat. C Bianco ◀

Structure upholstered in leather Colorata Cognac ▶  
Base in Bronze 100M finish with wheels  
77 x 84 x (46) 120 h





# reflex

## HEADQUARTER

Via Paris Bordone, 78/80  
31056 Biadade  
Treviso – Italy  
(+39) 0422 844440 - Italia  
(+39) 0422 844430 – Estero  
www.reflexangelo.com  
info@reflexangelo.com

## SHOWROOM BIANCADE

Via Gabriele D'Annunzio, 77  
31056 Biadade  
Treviso – Italy  
(+39) 0422 849201

## SHOWROOM MILANO

Via Madonnina, 17  
20121 Brera  
Milano – Italy  
(+39) 02 80582955

## SHOWROOM BERLINO

Taubenstrasse, 26  
D-10117 Berlino  
Germania  
(+49) (0)30 20 888 705  
berlin@reflexangelo.com

Nessuna parte di questo documento, testo o fotografia può essere riprodotta o trasmessa in qualsiasi forma o tramite mezzo elettronico o meccanico, comprese le fotocopie, senza previo permesso scritto da parte della società REFLEX SPA.

No part of this document, text or photo may be reproduced or transmitted in any shape or form, through electronic or paper-based communication, including photocopies, without the prior express written consent of REFLEX SPA.

I colori dei legni, delle laccature, dei tessuti e delle pelli presenti in questo catalogo sono suscettibili dei procedimenti di stampa. Fa fede il campionario dell'azienda. REFLEX SPA si riserva la facoltà di modificare in qualunque momento e senza preavviso le caratteristiche tecniche (misure, finiture, tessuti e pelli) dei suoi prodotti.

Wood, lacquer, fabric and leather colours are not binding and may vary due to printing. Please refer to the company sets of samples. REFLEX SPA reserves the right to modify the technical specifications of the products (sizes, finishes, leather and fabrics) featured in this catalogue at any time and without prior notice.



